



A+ Core Hardware Service Technician
EXAM #: 220-221
Number of questions: 384

Version 9.0

All rights reserved. This material is protected by copyright law and international treaties. Unauthorized reproduction or distribution of this material may result in severe civil and criminal penalties.

© Copyright 1999, 2000, 2001 and 2002 CheatExams Inc.

Q1. You find a BNC "push-and-turn" connector on the back of personal computers. What is it most likely used for?

- A. Connection to a network (LAN)
- B. Serial port
- C. Parallel port
- D. SCSI port

Answer: A

Q2. If the computer suddenly restarts and the lights flicker, which event probably occurred?

- A. electrical sag
- B. electrical surge
- C. prolonged power outage
- D. power overload and circuit shutdown

Answer: A

Q3. What would definitely cause an IDE hard drive to be damaged?

- A. forcing the IDE cable to the floppy drive connector.
- B. connecting one end of the IDE cable the wrong way.
- C. using a Y-splitter where the 5- and 12-volt connectors are switched on one end.
- D. connecting to a defective power supply that only gives 5 volts on the 12-volt line.

Answer: C

Q4. Which I/O port does the secondary IDE controller use?

- A. 134H
- B. 168H
- C. 170H
- D. 1F0H

Answer: C

Primary IDE Channel: 1F0-1F7

Secondary IDE Channel: 170-177

Q5. Which network cable is good for high speed and long distances?

- A. Shielded twisted pair
- B. Fiber optic
- C. Unshielded twisted pair

D. None of the above

Answer: B

Q6. How many IDE controllers are typically built into an ATX motherboard?

- A. 1
- B. 2
- C. 4
- D. 8

Answer: B

Q7. What is the function of an Energy Star-Compliant monitor?

- A. used only with fast processors.
- B. same as standard monitor types.
- C. switches to low-power states when signal does not change.
- D. consumes less power than other models while powering up.

Answer: C

Q8. The fan stopped working in the power supply, but the computer is still running. What is the proper repair procedure?

- A. Replace the fan.
- B. Replace the transformer.
- C. Lubricate the fan with oil.
- D. Replace the power supply.

Answer: D

Q9. What does 10BaseT mean?

- A. 10 Mbps, baseband transmission, twisted pair wire
- B. 10 Mbps, broadband transmission, twisted pair wire
- C. 10 Mbps, baseband transmission, Tempered wire
- D. 10 Mbps, broadband transmission, temporary wire

Answer: A

Q10. After replacing a keyboard with some good one, it is still not recognized by the system. What could be the problem?

- A. SETUP was not run.

- B. The BIOS needs to be flashed.
- C. The keyboard controller is not working.
- D. The processor is overheating.

Answer: C

Q11. A user often gets "Out of disk space" error. Which of the following actions should you consider? (Choose three.)

- A. Replace diskette drive.
- B. Add a larger hard drive.
- C. Add more RAM.
- D. Remove unneeded files.
- E. Defrag the existing hard drive.

Answer: B, D

Q12. Which protocol requires unique addressing through software configuration?

- A. IPX
- B. TCP/IP
- C. AppleTalk
- D. NWLink
- E. NetBEUI

Answer: B

Q13. A service technician is trying to master-slave two known good IDE hard drives, C and D. Drive D was installed as a slave to drive C, but both couldn't be made to work. The same problem occurred when drive C was installed as a slave to drive D.

Assuming that the technician used correct jumpering in both instances, what should he do next?

- A. Replace drive D, because it is now defective.
- B. Conclude that drives C and D are non-standard.
- C. Conclude that drives C and D are not compatible.
- D. Replace drives C and D, because both are now defective.

Answer: C

Q14. How would an ID logical 3 be set on a three-bit jumper block on a SCSI hard disk drive?

- A. 010
- B. 011

- C. 111
- D. 101

Answer: B

3 decimal is 011 binary ($4 \times 0 + 2 \times 1 + 1 \times 1 = 3$)

Q15. What is the first critical component that a failed motherboard battery affects?

- A. RAM
- B. ROM
- C. BIOS
- D. CMOS

Answer: D

Q16. How many devices does USB support?

- A. 32
- B. 64
- C. 127
- D. 256

Answer: C

Q17. Laser jet printer speeds are measured in pages per minute (PPM). What do we use to measure dot-matrix printers?

- A. lines per inch
- B. lines per sheet
- C. characters per inch
- D. characters per second

Answer: D

Q18. How is the LCD on a laptop powered?

- A. 120V AC
- B. 120V DC
- C. low-voltage DC
- D. low-voltage AC

Answer: C

Q19. When you arrive at the customer's desk, the computer is giving a continuous short beep noise that will not stop. What is the problem?

- A. A virus was downloaded from the Internet.
- B. The BIOS on the motherboard was corrupted.
- C. Improper software was loaded on the hard drive.
- D. A key on the keyboard is stuck in the down position.

Answer: D

Q20. A customer states that after someone borrowed a computer, a larger-than-normal black border appeared around the edge of the Windows desktop. What is the first logical question you would ask?

- A. Have you adjusted the contrast?
- B. Has the operating system just been upgraded?
- C. Have you checked to see if the video cable is loose?
- D. Have you checked the video monitor control settings?

Answer: D

Q21. Which of the following are associated with ROM? (Choose three.)

- A. DMA
- B. MBR
- C. BIOS
- D. POST
- E. CMOS

Answer: C, D, E

Q22. What does a "201" error indicate during POST?

- A. CPU error
- B. memory error
- C. video problem
- D. floppy drive error

Answer: B

POST errors in the 200-299 range indicates memory errors.

1xx: Motherboard errors.

2xx: RAM errors.

3xx: Keyboard errors

6xx: Floppy disk drive errors

11xx: COM1 errors

17xx: Hard drive errors

3xxx: NIC errors

Q24. What does an Ink-jet printer use to push ink onto the paper?

- A. nozzles
- B. air pressure
- C. static charge
- D. electro-conductive plates

Answer: A, D

Q25. What are the correct combinations of COM ports and IRQ? (Choose two.)

- A. COM1 and COM2, IRQ5
- B. COM3 and COM4, IRQ2
- C. COM1 and COM3, IRQ4
- D. COM1 and COM3, IRQ3
- E. COM2 and COM4, IRQ3

Answer: C, E

Q26. How should you open the tray on an inoperative CD-ROM drive?

- A. Push the Eject button.
- B. Push in on the lower-right corner door.
- C. Right-click the CD icon and select Eject.
- D. Insert a paper clip into the CD drive eject hole.

Answer: D

Q27. What type of logical topology does 10Base2 use?

- A. bus
- B. star
- C. ring
- D. tree

Answer: A

Q28. What can cause laser-jet printer to print too light? (Choose two.)

- A. Printing on wrong side of paper.
- B. Duplex mechanism inside printer.
- C. Too much humidity in the air.
- D. Malfunctioning transfer corona.

E. Malfunctioning high-voltage DC power supply.

Answer: C, D

Q29. You have just installed a 128 MB 168-pin Dimm chip on your ATX motherboard. You already had 128 MB in two 72-pin slots using Simm. When you turn on your system, it is only recognizing 128 MB of RAM total.

Which of the following are possible causes? (Choose three.)

- A. You need to upgrade or update your BIOS.
- B. BIOS is not set to read both types of memory.
- C. A jumper is not set to support both types of memory.
- D. The motherboard only supports one type of memory at a time.
- E. You need to remove one of the 172-pin memory chips so you have one of each.

Answer: A, B, D

Q30. What is the advantage of using ECC (Error Checking and Correction) memory?

- A. costs less money
- B. corrects cache errors
- C. corrects memory errors
- D. has more dense packaging

Answer: C

Q31. The POST test is run:

- A. Every time there is a cold boot
- B. Every time there is a warm boot
- C. Every time the AUTOEXEC.BAT file is run
- D. Just before the I/O.SYS file is run

Answer: A

Q32. What is the common language that computers use to talk with one another on a network?

- A. client
- B. adapter
- C. protocol
- D. operating system

Answer: C

Q33. What should you do after installing a new Ink-jet cartridge?

- A. Print a very detailed picture.
- B. Reboot your computer.
- C. Adjust the assignment manually.
- D. Run the printer alignment program.

Answer: D

Q34. What is the default I/O port for COM2?

- A. 2E8H
- B. 3E8H
- C. 2F8H
- D. 3F8H

Answer: C

COM1: 3F8H
COM2: 2F8H
COM3: 3E8H
COM4: 2E8H

Q35. How can you reset your CMOS password if you forget it? (Choose two.)

- A. Take out the CMOS battery and put it back in.
- B. By going into CMOS program and resetting it.
- C. Clear the CMOS by shortening the CMOS jumper.
- D. Go in to Windows 95 set up.

Answer: A, C

Q36. What does the POST definitely have to check? (Choose three.)

- A. Mouse
- B. Video
- C. CPU
- D. Hard Drive
- E. Memory

Answer: B, C, E

Q37. After installing a sound card, the system locks up when a parallel port tape backup unit also runs. Which of the following is most likely the problem. (Choose two.)

- A. IRQ
- B. DMA
- C. Defective LPT port
- D. Defective tape driver
- E. Defective sound card

Answer: A, B

Q38. The computer is unable to boot from a floppy. Which of the following is the most likely cause of the problem? (Choose two.)

- A. The floppy drive is defective.
- B. The floppy is formatted in FAT 16.
- C. The boot sequence is setup incorrectly in the system's BIOS.
- D. The HDD has more than one partition defined.

Answer: A, C

Q39. The resolution on a new 19" Ultra VGA monitor was set to 640x480 at 16 colors. You change the resolution to 800x600, high color (16-bit), and the monitor goes blank.

What is most likely the problem?

- A. The video card is using an IRQ.
- B. The video card is not installed properly.
- C. The monitor's trapezoid setting is off.
- D. The refresh rate is too fast for the monitor.

Answer: D

Q40. How is ink transferred to paper in common Ink-Jet printers?

- A. Pressure is built by boiling ink.
- B. Pressure is applied by using a crystal.
- C. Pressure is built by motorized pump.
- D. Ink is sprayed on by a nozzle.

Answer: A, D

Q41. An IDE drive can be set to use a specific connector on the cable by _____.

- A. Jumping for cable select (CS).
- B. Jumping connector for slave.
- C. Jumping connector for master.

D. Plugging the IDE cable into the second connector on the motherboard.

Answer: A

Q42. On a system with one hard drive and one CD-ROM, what is the typical placement of the CD-ROM drive?

- A. Slave drive on the primary IDE channel.
- B. Master drive on the primary IDE channel.
- C. Slave drive on the secondary IDE channel.
- D. Master drive on the secondary IDE channel.

Answer: D

Q43. You insert a floppy in the disk drive. You try to open the diskette. You get the error message: "Error Can't Access Device."

What is the most likely cause of this problem? (Choose two.)

- A. The floppy disk is damaged.
- B. The floppy drive is damaged.
- C. The floppy drive is dirty and you need to clean it.
- D. The floppy drive cable is broken, and must be replaced.

Answer: A, C

Q44. Which expansion slot can a SCSI adapter plug into? (Choose three.)

- A. PCI
- B. USB
- C. VL-VESA Bus
- D. EISA
- E. IEEE 1394

Answer: A, C, D

Most SCSI adapters use the PCI slot.

Q45. Where can you find your computer's BIOS version ID?

- A. On the back of the computer.
- B. In CMOS (or BIOS) set-up program.
- C. In System Manager.
- D. Painted on the motherboard.

Answer: B

Q46. The light in the room flickers and the computer suddenly reboots by itself. Which of the following occurred?

- A. Power Spike
- B. Virus
- C. Power Surge
- D. Blackout

Answer: A

Q47. You are upgrading a system. You are considering different motherboards. What CPUs can use Slot 1? (Choose three.)

- A. Pentium 233
- B. Celeron 300
- C. Pentium II 400
- D. AMD Athlon
- E. Pentium III 800

Answer: B, C, E

Celeron, Pentium II, and Pentium III processors can use Slot 1. Pentium II Xeon, Pentium Pro and Athlon processors cannot use Slot 1.

Q48. Which type of connector is used by analog modems?

- A. RJ-45
- B. BNC
- C. SCSI
- D. RJ-11
- E. BNC
- F. AUI

Answer: D

Q49. What is the main difference between an ATA/33 and ATA/66 cable?

- A. Cable color
- B. Twists in cables
- C. Prong layout
- D. Connector
- E. Cable pin out
- F. Number of wires

Answer: E

The ATA/33 cable has 40 connectors whereas ATA/66 has 80 connectors.

Q50. You replace your CMOS battery. What must you do next?

- A. None FDISK.
- B. Flash the BIOS.
- C. Set the date and time.
- D. Format the hard drive.

Answer: C

Q51. What does memory mapped to I/O do?

- A. Maps IRQ's to PCI cards.
- B. Acquires a unique ID for each memory module.
- C. Duplicates the contents of the ROM BIOS into RAM.
- D. Uses the specified memory address for peripherals.

Answer: D

Q52. Which one of the following options would cause the following error: "Bad or missing operating system on bootup"?

- A. No CD-Rom
- B. Missing or corrupt boot sector
- C. Slave HDD not powered up
- D. Bad Floppy drive connection

Answer: B

Q53. What information is not stored by BIOS?

- A. CPU Speed
- B. IDE hard drive configuration
- C. Time zone
- D. Wrist strap
- E. Unplug computer
- F. Keep the power on

Answer: D, E

Q54. How does a dot matrix printer actually print on paper?

- A. Letterhead

- B. Pins
- C. Platen
- D. By typing

Answer: B

Q55. Given two ATAPI devices, what determines which device will be the A: drive?

- A. Jumpers
- B. Twist in cable
- C. BIOS
- D. Terminators

Answer: B

Q56. In a dot matrix printer, what strikes the paper to create the intended image?

- A. Pins
- B. Trip Hammers
- C. Character Wheel
- D. Electromagnets

Answer: A

Q57. In the middle of printing several print jobs to a network dot matrix printer, the power goes out. When power is restored you are unable to get any print jobs from the printer.

What should you do to continue printing to this device?

- A. Press the Reload button on the printer.
- B. Delete existing print jobs from the printer buffer (spooler).
- C. Print the documents from a different PC on the network.
- D. Click on Print many times until the spooler clears.

Answer: B

Q58. How many DMA channels are there in an AT class PC?

- A. 3
- B. 4
- C. 7
- D. 8

Answer: B

In AT computers, the DMA-circuit had 4 DMA channels. Nowadays computers have 2 DMA-circuits, 4 channels each, with a total of 8 DMA channels.

Q59. A mouse pointer begins to move erratically jumping around when moved. What is the possible cause?

- A. The mouse ball is dirty.
- B. The mouse is not connected.
- C. The mouse driver is not installed properly.
- D. The mouse has an incorrect IRQ setting.

Answer: A

Q60. Your client has reported a problem with a slow connection to the Internet using a 56Kbps Modem. What are the most likely causes? (Choose two.)

- A. IRQ conflict.
- B. Insufficient RAM.
- C. Out dated modem driver.
- D. Noise on the telephone line.
- E. Modem on wrong serial port.

Answer: C, D

Q61. Which device connects to a parallel port?

- A. Mouse
- B. Joystick
- C. External Modem
- D. External Storage device

Answer: D

Q62. What would a failed processor fan most likely cause? (Choose all that apply.)

- A. CPU damage
- B. System lockups
- C. HDD failure
- D. FDD failure
- E. CD-ROM drive failure

Answer: A, B

Q63. Which of the following expose PCs to viruses? (Choose two.)

- A. A floppy from a friend.
- B. A downloaded file from the Internet.
- C. .dll file loaded with the OS.
- D. .cab file loaded with the OS.

Answer: A, B

Q64. Your printer is powered on and online. It has jobs in the printer queue but is not printing, what could be a probable cause?

- A. Printer driver overloaded
- B. Printer and CPU are not running at the same frequency.
- C. Printer is Offline enabled.
- D. Printer is in energy-save mode.

Answer: C

Q65. What is VRAM used for?

- A. Modems
- B. Video
- C. Network Card
- D. Sound Card

Answer: B

Q66. Which motherboard types accept 5 pin DIN keyboard connectors? (Choose two.)

- A. AT
- B. XT
- C. LT
- D. ATX

Answer: A, D

Q67. A client calls to report that after downloading a program from the Internet, her computer will not boot. What questions should you ask first?

- A. Were any modem errors reported?
- B. Is she on a local area network (LAN)?
- C. Was the file scanned for viruses?
- D. Was the downloaded software compatible with your system?

Answer: C

Q68. You have purchased three new USB devices and want to add them to your laptop but you only have one IRQ available. How many IRQs will your USB modem, mouse and keyboard use?

- A. 1
- B. 2
- C. 3
- D. 4

Answer: A

Q69. By default, which address does the primary IDE controller?

- A. 130H
- B. 170H
- C. 1F0H
- D. 300H

Answer: C

Q70. What must you do to attach a new IDE hard drive? (Choose three.)

- A. Select a unique ID
- B. Set the termination jumpers
- C. Set the master/slave jumper
- D. Ensure proper cable orientation
- E. Install drive bay and secure it properly

Answer: C, D, E

Q71. How are SCSI ID numbers prioritized? (Choose two.)

- A. 0 = lowest
- B. 0 = highest
- C. 1 = lowest
- D. 15 = lowest
- E. 15 = highest

Answer: B, D

Q72. Which of these devices are designed for an AGP slot?

- A. Hard drive
- B. Serial port
- C. Video card

D. External storage device

Answer: C

Q73. Which of the following chips are Slot 1 compatible? (Choose three.)

- A. Pentium 233 MMX
- B. PII 233
- C. PIII 333
- D. PIII 800
- E. AMD Athlon

Answer: B, C, D

Q74. You would have to enable int13h support on a SCSI controller card in order to use which device?

- A. Scanner
- B. Bernoulli
- C. Tape device
- D. Bootable CD-ROM

Answer: C

Q75. What statistic measures the time it takes a CRT's (Cathode Ray Tube) electron beam to paint the screen from top to bottom in a monitor?

- A. Dot pitch
- B. Interlacing
- C. Video RAM
- D. Refresh rate

Answer: D

Horizontal Refresh Rate (HRR) - The speed at which the electron beam runs across the screen.

Vertical Refresh Rate (VRR) - The amount of time it takes to draw the entire screen and return to the top left hand corner of the screen.

Dot Pitch - The diagonal distance between phosphorous dots of the same color.

Q76. Which two ports are most often used to connect a digital camera to a computer? (Choose two.)

- A. USB Port
- B. SCSI Port
- C. PS/2 Port

- D. Parallel Port
- E. RS-232 Port

Answer: A, E

Q77. Which AT command is used to reset your modem's configuration?

- A. AT
- B. ATD
- C. ATH
- D. ATZ
- E. ATM

Answer: D

Q78. You have recently started facing problems with your monitor. You notice that there is no monitor signal, no screen saver and no hibernation and you suspect that the problem lies in the video card.

You have three identical functioning systems in your office. What should you do to eliminate the video card as the cause of the problem switch with one of the functioning systems?

- A. Replace the motherboard.
- B. Replace the monitor.
- C. All flat ribbon cables.
- D. The video driver chip.

Answer: B

Either the monitor or the video adapter could be the cause of this problem. By replacing the monitor we could be sure if the video adapter is the source of the problem or not.

Q79. Which of the following is the first step in diagnosing a dead computer that worked fine only yesterday?

- A. Test the power supply
- B. Replace the CMOS battery
- C. Check the AC outlet
- D. Reseat the HDD cables

Answer: C

Q80. What type of CRT is 800x600?

- A. VGA
- B. XGA
- C. SVGA
- D. CGA

Answer: C

Q81. You just installed a new Plug-n-Play device in your desktop computer. How does BIOS assign resources?

- A. By checking manufacturer ID.
- B. By disabling all other devices, then assigning resources to the device.
- C. By calling Microsoft Support using ESP.
- D. By using the ESCD database and checking which resources are available. Then assigning appropriate resources to the Plug-n-Play device.

Answer: D

Q82. What is the I/O address for a primary hard drive?

- A. 170H
- B. 185H
- C. 070H
- D. 0H01
- E. 1F0H

Answer: E

Q83. A customer calls and states that the computer reboots on its own. What is the most likely cause of the problem?

- A. The BIOS is set to reboot periodically.
- B. The external SCSI CD-RW is using too much power.
- C. The CMOS is configured to power-cycle periodically.
- D. The power supply is not providing enough power to the system.

Answer: D

Q84. A customer reports that the computer freezes after the initial memory count, so CMOS cannot be accessed. What part should you arrive with?

- A. CPU
- B. Modem
- C. Video Card
- D. Floppy Disk

Answer: A

Q85. What is the purpose of shadowing?

- A. Copy ROM BIOS information into the Reserved Memory area of RAM for faster execution.
- B. Hide instructions
- C. Encrypt important files
- D. Protect against virus attacks

Answer: A

Q86. What does memory mapped I/O do?

- A. Maps IRQs to PCI interface cards.
- B. Acquires a unique ID for each memory module.
- C. Duplicates the contents of the ROM BIOS into RAM.
- D. Uses the same address space for memory locations and peripheral devices.

Answer: D

Q87. Your modem will not detect a dial tone. What are the two most likely reasons? (Choose two.)

- A. Cable is not plugged in.
- B. The phone line is defective.
- C. The modem is set for tone dial.
- D. The Internet service provider is down.
- E. The modem is set to disable call waiting.

Answer: A, C

Q88. A service technician just added a slave hard drive to a working PC. When the PC is powered on, it just gives a blank screen. What is the most likely cause of this problem?

- A. Missing floppy cable.
- B. CMOS configuration error.
- C. Hard drive cable connection.
- D. Incompatible slave hard drive.

Answer: D

Q89. In a system with multiple hard drives, what are the benefits of using multiple fans? (Choose two.)

- A. Increased memory bandwidth.
- B. Increased speed of data transfers.
- C. Cool air outside the computer.
- D. Redistribute airflow through the system.
- E. Reduced internal component temperature.

Answer: D, E

Q90. Which of the following bi-directional parallel port modes has the highest throughput?

- A. SPP
- B. ECP
- C. EPP
- D. RAW

Answer: B

Both ECP and EPP use bidirectional communication. EPP only allow communication in one direction i.e., half duplex, while ECP allows simultaneous bi-directional communications i.e., full duplex. ECP is therefore faster than EPP. (ECP uses 8 bits, and EPP uses only 4 bits.)

Q91. The floppy drive's LED is up and stays that way from the time the machine is powered on. What is the most likely cause of this problem?

- A. CMOS configuration error.
- B. A disk left in the floppy drive.
- C. Floppy drive cable connection.
- D. Hard drive failure.

Answer: C

The floppy drive cable connection has been applied backwards.

Q92. What is the POST code for FDD failure?

- A. 3xx
- B. 2xx
- C. 5xx
- D. 6xx
- E. 7xx

Answer: D

Q93. Why would a laser printer print a blank page when the drum does have an image written on it?

- A. Transfer corona failure.
- B. Bad communications between computer and printer.
- C. Corrupt driver.
- D. Rollers need lubrication.
- E. Low Toner.
- F. Fuser failure.

Answer: A

Q94. What is the base address of the video card?

- A. 0000-C7FF
- B. C000-CAAA
- C. D000-D800
- D. D000-DAAA

Answer: A

Q95. You just installed a new HDD on your desktop computer. The system BIOS will not recognize it. Which of the following should you check first?

- A. Cable sequence
- B. Jumper selection for Slave/Master on the HDD.
- C. Drivers
- D. Web site for HDD manufacturer

Answer: B

Q96. With respect to a NIC (network interface card), the term 10/100 refers to:

- A. Protocol speed
- B. Fiber Optic Speed
- C. Megabits per second (Mbps)
- D. Minimum and Maximum speeds

Answer: C

Q97. Which of the following cable types is required for 100BaseT cable?

- A. Cat 1
- B. Cat 2
- C. Cat 3

D. Cat 5

Answer: D

Q98. Which of the following is NOT a feature of a machine protected by a UPS?

- A. Long term power supply.
- B. Short term power supply.
- C. Surge protection.
- D. Power lag protection.

Answer: A

Q99. A bent pin on a 3 door DB-15 male connector plug could cause problems with which device or component?

- A. Monitor
- B. Mouse
- C. Printer
- D. External modem

Answer: A

Q100. How many IRQ's does a chain of USB devices require?

- A. 1
- B. 2
- C. 3
- D. 4

Answer: A

Q101. Which of the following devices does SCSI support? (Choose three.)

- A. CD-ROM
- B. Tape Devices
- C. Modem
- D. HDD
- E. Video Card
- F. Sound Card

Answer: A, B, D

Q102. Which of the following needs to be used for networking two PC's using Ethernet peer-to-peer over RJ-45 cabling?

- A. Power cable
- B. Printer cable
- C. HDD cable
- D. Crossover cable

Answer: D

Q103. How many devices can function on a single IDE channel?

- A. 1
- B. 2
- C. 3
- D. 4

Answer: B

Q104. When installing a second HDD in a Plug and Play system, what determines the drive letter?

- A. End user
- B. Positioning of the cable
- C. Operating system
- D. Drive manufacturer

Answer: B

Q105. What is 10baseT maximum cable length?

- A. 100m
- B. 130m
- C. 150m
- D. 1000m

Answer: A

Q106. What can jumpers set on a NIC card? (Choose all that apply.)

- A. Protocol
- B. IRQ
- C. MAC
- D. Memory address

Answer: B

Q107. Which of the following are important trouble shooting questions to ask a user when gathering information about an issue? (Choose two.)

- A. Who caused this issue?
- B. When did this issue begin?
- C. Where did you buy your computer?
- D. What were you doing when the issue began?
- E. How much did your computer cost?

Answer: B, D

Q108. What is a new printer cable?

- A. USB
- B. Parallel
- C. Serial
- D. SCSI

Answer: A

Q109. Which of the following cable types can you use to network two computers? (Choose three.)

- A. IDE
- B. Serial
- C. SCSI
- D. Parallel
- E. 10Base2

Answer: B, D, E

Q110. A video resolution of 800 x 600 is equivalent to which video mode?

- A. EGA
- B. VGA
- C. CGA
- D. SVGA

Answer: D

Q111. A user cannot log on to the local area network (LAN) you support, but his neighbors have no such problems. From your workstation you attempt to log in as the user with his username and password and do not experience any problems.

However you cannot log in from his workstation with any account. What is the most likely cause of this problem?

- A. Server malfunction.
- B. Bad station patch cables.
- C. Wrong username or password.
- D. Insufficient server access rights.

Answer: B

Q112. Which component on a printer should you check first when an error code indicates a paper jam but no paper is in the printer?

- A. Tractors
- B. Print head
- C. Platen folder
- D. Paper-Feed Sensors

Answer: D

Q113. What is the minimum cable type specified by 100BaseTX?

- A. Category 3
- B. Category 4
- C. Category 5
- D. Category 6

Answer: C

Q114. Which of the following configuration settings are set in EEPROMS on a NIC? (Choose three.)

- A. IRQ
- B. Protocol
- C. IP Address
- D. I/O Address
- E. MAC address

Answer: A, D, E

Q115. Which of the two following tools can be used to clean the interiors of a computer? (Choose two.)

- A. Magnet
- B. Canned Air
- C. Small brush
- D. Sponge

Answer: B, C

Q116. What has occurred when HDD fails, making a grinding noise?

- A. Controller failure
- B. The Read/Write head is in contact with the platter
- C. Hard drive is in power save
- D. Hard drive is in labor

Answer: B

Q117. Which devices have similar looking connectors? (Choose two.)

- A. USB
- B. PS/2 Mouse
- C. ATX Keyboard
- D. Parallel Printer
- E. SCSI Scanner

Answer: B, C

Q118. What is different about a Vacuum for a computer compared to a standard Vacuum?

- A. Less ESD
- B. More ESD
- C. Blows less forcefully
- D. Sucks less forcefully

Answer: A

Q119. What is the default IRQ for LPT1?

- A. 2
- B. 5
- C. 7
- D. 13

Answer: C

Q120. Which expansion slot can a SCSI adapter plug into? (Choose three.)

- A. PCI
- B. USB
- C. EISA

- D. VL-BUS
- E. IEEE 1394

Answer: A, C, D

Q121. Which device contains its own BIOS?

- A. DRAM
- B. HDD
- C. Video Adapter
- D. CD-ROM

Answer: C

Q122. When replacing a power supply, what must you observe?

- A. Voltage
- B. Current
- C. Wattage
- D. Resistance

Answer: C

Q123. What does TCP/IP support? (Choose three.)

- A. NWLink
- B. Ethernet
- C. Token Ring
- D. Modem 7Dial-up

Answer: B, C, D

Q124. When servicing a laser printer which part should be avoided because of high temperatures?

- A. Fuser
- B. Print head
- C. Corona
- D. Power Supply

Answer: A

Q125. What is the main communication method between one PDA (personal digital assistant) to another PDA?

- A. Infrared (IR)
- B. USB
- C. RS-232
- D. IEEE 1394

Answer: A

Q126. Which of the following are considered to be consumables on a printer?
(Choose two.)

- A. Print Heads
- B. Ribbons
- C. Corona Wires
- D. Paper

Answer: B, D

Q127. Which of the following is a consequence of enabling shadowing in a computer BIOS?

- A. Instructions stored in various ROM chips are copied into RAM.
- B. Values are stored twice in memory for redundancy checking.
- C. Conventional memory is remapped to the top of extended memory.
- D. Data stored in RAM and adaptive card is shadowed into extended memory.

Answer: A

Q128. What are the two main differences between AT and ATX motherboards?
(Choose two.)

- A. PS/2 port
- B. BNC connector
- C. Soft Power switch (Power button is electrical not mechanical)
- D. Serial connectors
- E. Parallel connectors

Answer: A, C

Q129. You get a CMOS checksum error upon boot. What is the most likely cause?

- A. Faulty power supply.
- B. Faulty RAM.
- C. Faulty Processor.

- D. HDD types incorrectly defined.
- E. CMOS battery is nearing end of life.

Answer: E

Q130. What are the most probable causes of motherboard failure? (Choose all that apply.)

- A. Power failure during Bios update.
- B. Power failure during printer update.
- C. Plugging in a USB while powered up.
- D. Plugging in a ps2 mouse while powered up.
- E. Plugging in a serial mouse while powered up.

Answer: A, D

Q131. What can be done when a system's IDE controller fails? (Choose two.)

- A. Replace the motherboard
- B. Install an add-on card
- C. Replace the HDD
- D. Replace the cable
- E. Install a new driver.

Answer: A, B

Q132. What is your first action when your HDD reports that it is developing bad sectors?

- A. Replace the drive
- B. Run SECCLEAN from DOS
- C. Run DEFRAG
- D. Run SCANDISK with the "Thorough" option selected

Answer: D

Q133. The computer has a 56Kbps modem. It is connected to Internet through an ISP. The user of the computer complains that the Internet usage is very slow.

What are the most likely causes of this problem? (Choose two.)

- A. IRQ conflict
- B. Bad phone cable
- C. Old device drivers for the modem
- D. Noisy telephone line

E. The ISP is down

Answer: C, D

Q134. Which is not a valid AMD CPU?

- A. K6
- B. K5
- C. K8
- D. Athlon

ANSWER: C

Q135. Which problems will not be recognized by initial POST?

- A. Bad memory location.
- B. ROM BIOS configuration failure.
- C. A stuck key or defective keyboard.
- D. A RAM chip that fails at high temperature.

Answer: D

Q136. Which interrupt (IRQ) is cascaded to provide interrupts 9 through 15?

- A. 1
- B. 2
- C. 3
- D. 4

Answer: B

Q137. Silicon lubricant can be applied on which of the hardware devices?

- A. Mouse
- B. Keyboard
- C. Read/Write Heads
- D. Rollers in Printer

Answer: B

Q138. What is the major difference between EDO RAM and Fast Page Mode RAM?

- A. EDO RAM is cheaper than Fast Page Mode RAM.
- B. EDO RAM is faster than Fast Page Mode RAM.
- C. EDO RAM is slower than Fast page RAM slower.

D. EDO RAM is physically larger than Fast page RAM slower.

Answer: B

Q139. A large document causes memory overflow errors on your laser printer. Which of the following are possible fixes? (Choose three.)

- A. Reseat the printer cable.
- B. Decrease the print resolution.
- C. Add more RAM to the printer.
- D. Reduce the spooler size.
- E. Replace the toner cartridge.
- F. Reduce the RET (Resolution Enhancement Technology)

Answer: B, C, F

Q140. A workstation has been installed on a LAN, but is unable to communicate with the network. What should you do first?

- A. Reinstall the protocol.
- B. Reinstall the NIC driver.
- C. Verify the IP configuration on the workstation.
- D. Verify the link status on the NIC (network interface card).

Answer: D

Q141. For computers not protected by a UPS, what problem can occur when power is restored after a power failure?

- A. ROM needs to be reprogrammed.
- B. Damage from a power surge.
- C. The CMOS has a battery failure.
- D. The Motherboard switch needs to be reset.

Answer: B

Q142. A BIOS password has been enabled on a critical computer, and the password has been forgotten. How do you recover? (Choose two.)

- A. Fdisk the primary hard drive.
- B. Temporarily remove the CMOS battery.
- C. Go into BIOS setup and delete the password.
- D. Clear the CMOS by shorting the CMOS jumper.
- E. Boot the computer while holding down the key.

Answer: B, D

Q143. Which CPU is intended to operate at a 66MHZ motherboard speed?

- A. Intel 80486
- B. Pentium 75
- C. Pentium II 350
- D. Pentium II 300

Answer: D

Q144. When you boot up your computer the light on the diskette drive lights up and stays lit. What does this mean?

- A. Disk is in the drive.
- B. No disk is in the drive.
- C. The data cable is installed backwards.
- D. The diskette drive is functioning properly.

Answer: C

Q145. A customer reports that her computer will not boot. She hears noises and sees lights inside the box, but nothing shows up on the monitor.

Which of the following is the most likely cause of this problem?

- A. HDD
- B. Video Card
- C. Power Cable
- D. Power Supply

Answer: B

Q146. What is the set of rules used to transmit data from one computer to another called?

- A. Service
- B. Adapter
- C. Protocol
- D. Network operating system

Answer: C

Q147. Which precaution must be taken when installing a video card with onboard memory?

- A. Unplug the PC.
- B. Flash the BIOS.
- C. Use ESD straps.
- D. Leave the power on.

Answer: A

Q148. Which of the following is the latest type of connector for a printer interface?

- A. USB
- B. Serial
- C. SCSI
- D. Parallel

Answer: A

Q149. What is the minimum cable type for 10baseT?

- A. Cat 3
- B. Cat 4
- C. Cat 5
- D. Cat 6

Answer: A

Q150. What is the highest possible ID on a 3 jumper block SCSI device?

- A. 3
- B. 6
- C. 7
- D. 15
- E. 32

Answer: C

Q151. A technician places a second HDD as a slave on the only IDE controller. The primary drive is no longer detected. How should you troubleshoot this?

- A. Replace the Primary HDD
- B. Replace the Secondary HDD
- C. Rejumper the CD-ROM
- D. Jumper the second HDD as a master and test it alone

Answer: D

Q152. Which of the following types of memory are used in a computer? (Choose three.)

- A. RIMM
- B. SIMM
- C. DIMM
- D. VRTRAM
- E. CRAM
- F. PTRAM

Answer: A, B, C

Q153. Which drive letter will be assigned to the drive at the end of the cable twist?

- A. A
- B. B
- C. C
- D. D

Answer: A

Q154. A customer just installed a new CD-RW. The system was working fine before the installation, but now the CD-ROM is inoperable. What should you suggest the customer to do?

- A. Flash the BIOS
- B. Check the CONFIG.SYS
- C. Add the CD-RW in the device manager.
- D. Check the jumper settings on the CD-RW

Answer: D

Q155. When installing a new printer, which of the following are possible causes of several lines of code being printed followed by several blank pages? (Choose two.)

- A. Wrong printer driver
- B. Empty toner cartridge
- C. Overloaded paper tray
- D. Loose printer cable
- E. Faulty surge protector

Answer: A, D

Q156. What is the most significant difference between USB and IEEE 1394?

- A. IEEE 1394 is faster.
- B. IEEE 1394 does not support USB.
- C. USB is PNP.
- D. IEEE 1394 is hot swappable.

Answer: A

Q157. Your system was working perfectly yesterday. Suddenly you get a "CMOS configuration mismatch" error. What should you do next?

- A. Verify that all devices are getting power.
- B. Erase the CMOS settings and reconfigure.
- C. Check the settings of the hard drive.
- D. Check the voltage of the CMOS battery.

Answer: D

Q158. Which interrupt (IRQ) is reserved for the system timer?

- A. 0
- B. 1
- C. 8
- D. 13

Answer: A

Q159. What is unique about each device on a SCSI chain?

- A. I/O
- B. LUN
- C. Identification
- D. Master or Slave

Answer: C

Q160. What expansion bus type is supported by most motherboards?

- A. MCA, PCI
- B. ISA, EISA
- C. ISA, PCI, AGP
- D. PCI, DIMM, SIMM

Answer: B

Q161. How many bits wide is the data bus for a 168 pin DIMM?

- A. 16-bit
- B. 32-bit
- C. 64-bit
- D. 128-bit

Answer: C

Q162. How should you place terminations on a SCSI bus with one internal HDD and one external CD-ROM?

- A. Terminate the HDD only.
- B. Terminate the SCSI interface card.
- C. Terminate both the HDD and the CD-ROM.
- D. Terminate the SCSI card, HDD, and the CD-ROM.

Answer: C

Q163. Which setting must be correctly configured in order to interrupt the CPU?

- A. IRQ
- B. I/O Address
- C. DMA channel
- D. Memory address

Answer: A

Q164. What is the most important feature to look for when replacing your mouse?

- A. color
- B. connector
- C. the number of buttons.
- D. the manufacturer and model number.

Answer: B

There are several different mouse connectors e.g., serial, USB, and IR.

Q165. You have an internal SCSI hard drive as well as an external SCSI hard drive, where do you put the terminations?

- A. You put one the controller and one on the internal SCSI hard drive.
- B. You put one at the end of each hard drive and NOT one on the controller.
- C. You put one the controller and one on the external SCSI hard drive.
- D. You put one on the controller.

E. You put one on the internal SCSI hard drive.

Answer: B

Q166. Your dot matrix printer prints dark on the left side and then gets lighter towards the right. What is the likely cause of this problem?

- A. Defective print head.
- B. Worn ribbon.
- C. Paper not advancing properly.
- D. Defective carriage assembly.
- E. Worn platen.
- F. Misaligned platen.

Answer: F

Q167. Which IRQ cascades to #9?

- A. 0
- B. 1
- C. 2
- D. 3

Answer: C

Q168. How many IDE hard drives can you connect to an IDE-channel?

- A. 1
- B. 2
- C. 3
- D. 4

Answer: B

Q169. A girl is having a problem with the network. She can't log on from her computer. She can't use her Internet either. You log on to your workstation using her username and password. Everything works fine.

What is most likely the problem?

- A. Server is down.
- B. Defective patch cable used at her computer.
- C. She does not have sufficient user rights.
- D. ISP is down.

Answer: B

Q170. What is the maximum distance for a 10Base2 (thinnet) segment?

- A. 100 meters
- B. 185 meters
- C. 330 meters
- D. 1000 meters

Answer: B

Q171. You install a Plug-n-Play hard drive. How is its drive letter assigned by the computer?

- A. By its position on the cable.
- B. By its IRQ.
- C. By its jumper settings
- D. By magic.

Answer: A

Q172. After inserting a floppy disk and accessing the A: drive, you get the following error message: "Drive A not ready. Abort, Retry, Fail."

What two things should you suspect first? (Choose two.)

- A. The drive is bad.
- B. The floppy disk is bad.
- C. The drive cable is bad.
- D. The power connector is loose.
- E. The floppy drive is dirty and needs to be cleaned.

Answer: B, E

Q173. While playing a stereo CD audio, adjusting the left hand speaker's volume from Windows, effects the right hand speakers instead. What are the most probable causes? (Choose two.)

- A. An IRQ conflict exists.
- B. The volume controls are muted.
- C. An incorrect CD audio cable was used.
- D. You need to run windows utility from the correct working directory.
- E. The right hand speaker is plugged at the wrong connector on the sound card.

Answer: C, E

Q174. In a Laser printer, what is the most common cause of a wavy image on the paper?

- A. Damaged fuser
- B. Smooth pickup rollers
- C. Defective LASER scanner
- D. Defective toner cartridge

Answer: D

Q175. Which of the following cable types can be used to create a network of two computers? (Choose three.)

- A. IDE
- B. Serial
- C. SCSI
- D. Parallel
- E. UTP

Answer: B, D, E

Q176. How many devices can be connected on a fast/wide SCSI2 bus?

- A. 7
- B. 8
- C. 12
- D. 15

Answer: D

Q177. A ZIF socket was put on the motherboard to help with inserting and removing _____ ?

- A. CPUs
- B. SIMMS
- C. DIMMS
- D. CPU FANS

Answer: A

Q178. What is the motherboard speed setting for a Pentium-200?

- A. 50 MHZ
- B. 60 MHZ
- C. 66 MHZ
- D. 200MHZ

Answer: C

Q179. How many 72 pin SIMMs are required when using a socket 7 motherboard?

- A. 1
- B. 2
- C. 4
- D. 6

Answer: B

Q180. Which are valid types of parallel ports? (Choose three.)

- A. EPP
- B. EEP
- C. ECP
- D. USB
- E. Bi-directional

Answer: B, C, E

Q181. How toner cartridges are disposed off?

- A. Burned
- B. Thrown away
- C. Recycled by the manufacturer.
- D. Recycled with the standard plastic.

Answer: C

Q182. Uninterruptible Power Supply is also known as?

- A. Battery Backup
- B. Circuit Breaker
- C. Surge Strip
- D. Power Herper

Answer: A

Q183. What is the proper storage environment for OPC (Organic PhotoConductive Drums)?

- A. Cool and Bright
- B. Cool and Dark

- C. Humidity free
- D. Warm and Dark

Answer: B

Q184. How many print head pins would be there on a standard paper quality dot matrix printer?

- A. 9
- B. 15
- C. 24
- D. 25

Answer: C

Q185. In the fusing stage of the laser printing process, the_____ .

- A. Primary corona wire gives a charge to the photosensitive drum.
- B. Laser writes the image that it will print to the photo sensitive drum.
- C. Toner transfers to the corona.
- D. Printer melts the written image to the paper.

Answer: D

Q186. Which type of connector is used for a parallel connection on the end that connects to the printer?

- A. 9-Pin (DB-9) male
- B. 25-Pin (DB-25) male
- C. 25-Pin (DB-25) female
- D. Centronics (36-pin) D-shell

Answer: D

Q187. What is the memory contained inside the CPU called?

- A. ROM
- B. RAM
- C. CACHE
- D. VIRTUAL

Answer: C

Q188. What does a 28 dot pitch refer to in describing a monitor?

- A. .28 cm apart.
- B. .28 millimeter wide.
- C. .28 cm wide.
- D. .28 millimeter apart
- E. .28 pixels apart.
- F. .28 pixels wide.

Answer: D

Q189. A technician places a second HDD as a slave on the only IDE controller. The second HDD installed correctly, but is not auto detected by the BIOS. How should you troubleshoot this?

- A. Replace the Primary HDD
- B. Replace the Secondary HDD
- C. Rejumper the CD-ROM
- D. Jumper the second HDD as a master with no slave.

Answer: D

Q190. You get an error during POST on your computer. What could this mean? (Choose two.)

- A. BIOS needs to be reset.
- B. There is a hardware failure.
- C. HIMEM.SYS is missing or incorrect.
- D. The drivers for the device are incorrect.
- E. The Windows file system is generating an error.

Answer: A, B

Q191. You just installed a Pentium II 600-MHz chip. When you boot up your computer, it only recognizes 400-MHz chip. What is the most likely cause of this problem?

- A. Only half of the chip is installed into the socket.
- B. The jumper settings on the chip are not correct.
- C. You do not have enough space on your hard drive.
- D. The BIOS setting is not reflecting a multi-speed setting.

Answer: D

Q192. You have just performed a clean installation of Windows 2000 Server and removed the installation CD from the drive. When you reboot your system you receive the following error message: "Can't find a bootable CD-ROM device."

What should you do to solve this problem?

- A. Replace your hard drive, run FDISK, and re-install the OS.
- B. Reinstall the ATAPI driver.
- C. Check if MSCDEX is loaded in CONFIGBAT.
- D. Change the BIOS boot sequence to A, C, CD-ROM.

Answer: D

Q193. What are the minimum hardware components required for the POST to pass? (Choose all that apply.)

- A. CPU
- B. RAM
- C. Mouse
- D. Hard drive
- E. Video Card

Answer: A, B, E

Q194. You install a network interface card (NIC) that is not plug and play in your computer and see several jumpers on the card that allow you to change various settings. Which NIC setting do jumpers allow you to change? (Choose two.)

- A. IRQ
- B. Token size
- C. MAC address
- D. Memory address
- E. Communication protocol

Answer: A, D

Q195. Which expansion slot can a SCSI adapter plug into? (Choose two.)

- A. PCI
- B. USB
- C. IEEE 1264
- D. EISA
- E. IEEE 1394

Answer: A, D

Q196. You are upgrading your system. You are considering different motherboards. What CPUs can use Slot 1? (Choose two.)

- A. Pentium 233

- B. Pentium II Xeon
- C. Pentium II 400
- D. AMD Athlon
- E. Pentium III 800

Answer: C, E

Celeron, Pentium II, and Pentium III processors can use Slot 1. Pentium II Xeon, Pentium Pro and Athlon processors cannot use Slot 1.

Q197. When upgrading to a Pentium II, which slot or socket is viable?

- A. Slot 1
- B. Slot A
- C. Slot 3
- D. Socket 7

Answer: A

Celeron, Pentium II, and Pentium III processors can use Slot 1.

Q198. What should you do first if the mouse pointer is not moving correctly across the screen?

- A. Clean the mouse dirt.
- B. Plug into a different port.
- C. Check the mouse drivers.
- D. Reconfigure the system.

Answer: A

Q199. What causes chip creep?

- A. Thermal expansion and contraction.
- B. Overheating of chips due to electrical shorts.
- C. Chips that don't communicate with other chips.
- D. Chips memory that is incompatible with the motherboard.

Answer: A

Q200. Which memory address range is reserved for VGA video card?

- A. 0000-C3FF
- B. 0000-C7FF
- C. D000-D7FF
- D. D000-DFFF

Answer: B

Q201. Silicon lubricants can be used for _____ .

- A. Drive heads
- B. SIMM installations
- C. Keyboard performance
- D. Floppy disk drive door mechanisms

Answer: C

Q202. Which interrupt (IRQ) does the real-time clock use?

- A. 0
- B. 1
- C. 8
- D. 13

Answer: C

Q203. Typically in which of the following would you use a PC card?

- A. Laptop
- B. Desktop
- C. Laser printer
- D. Docking station

Answer: A

Q204. What is the DMA channel for the floppy drive controller?

- A. 1
- B. 2
- C. 3
- D. 4

Answer: B

Q205. What do you need to do when replacing the motherboard in a portable computer?

- A. Ensure that the board is AT or ATX.
- B. Ensure that the board is from that manufacturer and the boards are interchangeable.
- C. Match the manufacturer and the model number exactly.

D. Any motherboard will act as long as it is specified for a laptop.

Answer: B

Q206. What is the data bus width for an ISA slot?

- A. 12
- B. 16
- C. 32
- D. 64

Answer: B

Q207. Intel's Single Edge Contacts (SEC) design contains both a CPU and a _____ .

- A. L1 Cache
- B. L2 Cache
- C. L3 Cache
- D. L4 Cache

Answer: B

Q208. What is the default IRQ for COM2?

- A. 2
- B. 3
- C. 4
- D. 6

Answer: B

COM2 and COM4 use IRQ3
COM1 and COM3 use IRQ4

Q209. What is the most important step when upgrading the BIOS?

- A. Shut off the UPS.
- B. Write down all the settings.
- C. Unplug all connectors.
- D. Save the BIOS upgrade files on to a floppy disc.

Answer: B

Q210. What is the main feature of SDRAM?

- A. Locating the boot sector.
- B. Using fewer transistors.
- C. Transferring the BIOS information.
- D. Delivering the data in high speed bursts.

Answer: D

Q211. What should you use to clean circuit board contacts?

- A. An emery cloth
- B. Jeweler's cloth
- C. Silicone spray
- D. Contact cleaning solution

Answer: A

Q212. You have an older PC that only has one IDE interface, one IDE hard drive and one IDE CD-ROM drive. How should you add a second IDE hard drive?

- A. Install a SCSI card.
- B. Install an add-on IDE interface card.
- C. Use an IDE cable that has extra connections on it.
- D. Use the existing free connector on the floppy drive cable.

Answer: B

Q213. Which of the following are considered types of video RAM? (Choose three.)

- A. VRAM
- B. LRAM
- C. WRAM
- D. DRAM
- E. SGRAM

Answer: A, C, E

Q214. You have just installed a new CD-ROM drive on the secondary controller with an IDE external storage device and now neither device works. What should you do to solve this problem?

- A. Check master/slave jumpers.
- B. Install new CD-ROM drivers.
- C. Plug in the CD-ROM drive power cable.
- D. Delete the drivers for the external storage device.

Answer: A

Q215. Your Windows desktop on your monitor appears to be distorted. What should you do to isolate the problem? (Choose two.)

- A. Try another program.
- B. Try another monitor.
- C. Install additional video memory.
- D. Replace the power supply.
- E. Boot the computer to a command prompt.

Answer: B, E

Q216. What is the most likely cause of a sound card and a printer working intermittently?

- A. The wrong AMP setting.
- B. An improperly seated card.
- C. Conflicting IRQs.
- D. A changed printer cable.

Answer: C

Q217. Which devices can cause interference with a modem connection? (Choose two.)

- A. Fan
- B. Phone
- C. Printer port
- D. Fax machine
- E. Power supply

Answer: B, D

Q218. Which features of a SCSI-2 enables a device to accept multiple instructions?

- A. Dual channel
- B. Line queen
- C. Command queuing
- D. Multi LUN support

Answer: C

Q219. The process of refreshing memory is the process of _____ .

- A. Cleaning the memory for reuse.
- B. Testing the memory chip registers.
- C. Recharging or re-energizing the registers.
- D. Deleting memory before shutting down the system.

Answer: C

Q220. You had just made a floppy boot disk and want to test it. You put the disk in the drive and restart the computer but it boots up to the Windows 9x GUI.

What is the most likely cause of this problem?

- A. The BIOS is set to boot the hard drive first.
- B. You left your windows 9x CD in the CD-ROM drive.
- C. You did not set the boot sector of the disk to active.
- D. The disk is set to write protect.

Answer: A

Q221. You just installed a second IDE slave hard drive to the primary controller in your Windows 9x system. You double click My Computer and cannot see the second drive there.

What are the two most likely causes for this problem? (Choose two.)

- A. The floppy drive is not connected.
- B. The proper drivers are not loaded.
- C. Your hard drive is not partitioned.
- D. Device manager needs to be refreshed.
- E. The BIOS has not been updated.

Answer: C, E

Q222. Which of the following must be changed when replacing a hard drive? (Choose two.)

- A. Voltage
- B. DMA channel
- C. Controller address
- D. Cable orientation
- E. Drive select jumper

Answer: D, E

Q223. Under what circumstances is it necessary to replace the CMOS chip?

- A. When the CMOS is full.
- B. When you upgrade the CPU.
- C. If it is a non flash type.
- D. After you have flashed it several times.

Answer: C

Q224. You just changed the monitor refresh rate in Windows 95 and now the desktop is not available. What should you do first to correct this problem?

- A. Boot Windows in Safe mode.
- B. Replace the video card.
- C. Run VIDFIX.EXE from a DOS prompt.
- D. Change the video setting in the BIOS configuration.

Answer: A

Q225. Which of the following are FRUs (Field Replaceable Units)? (Choose three.)

- A. RAM
- B. ROM
- C. CPU
- D. CMOS battery
- E. ZIFFSOCKET

Answer: A, C, D

Q226. Your external modem is not functioning properly and you suspect that a malfunctioning serial port is the problem. Which tool should you use to test the serial port?

- A. Post card
- B. Multimeter
- C. Loopback plug
- D. Null modem cable

Answer: C

Q227. Which of the following needs to be set up on SCSI drives? (Choose two.)

- A. ID
- B. Voltage
- C. Cable length
- D. Terminators

Answer: A, D

Q228. You have a jumpered modem that could only take the standard COM1 and COM 2 ports. Which step will help when installing the modem in a Windows 9x computer?

- A. Disable the second serial port in CMOS.
- B. Use manual setting for COM1 and set it to IRQ file.
- C. Free the IRQ tied up by the floppy drive controller.
- D. Ensure that the second and third USB devices are not conflicting with the IRQ.

Answer: B

Q229. Which settings determine which IDE device are master and which is slave?

- A. Hardware settings on the device.
- B. Hardware settings on the IDE controller board.
- C. Hardware settings on the mother board.
- D. Software settings on the operating system.

Answer: A

Q230. A user calls support and says that his system will not boot up. He receives the following error message: "missing operating system." What is the most likely cause of this error?

- A. The key board is not working or is plugged in improperly.
- B. A non bootable disk is in the disk drive.
- C. The Windows 9x CD is in the CD ROM drive.
- D. The Windows 9x CD is not in the CD ROM drive.

Answer: B

Q231. Which IRQs are assigned first?

- A. Hardware configured
- B. CMOS configured
- C. Windows 9x legacy
- D. Windows 9x plug and play

Answer: B

Q232. Where are the system date and time maintained when the system is turned off?

- A. In RAM

- B. In CMOS
- C. In the hard drive
- D. In the power supply

Answer: B

Q233. Why should you have slot covers installed in a computer? (Choose two.)

- A. CPU warmer.
- B. Keep dust out.
- C. Protect against ESD.
- D. Improve air flow.
- E. Prevent installing unnecessary components.

Answer: B, D

Q234. A dot matrix printer is printing patchy, faint or uneven characters. What should you do to correct this problem?

- A. Replace the ribbon.
- B. Replace the timing belt.
- C. Adjust the paper feed tension.
- D. Adjust the tractor feed tension.

Answer: A

Q235. Which of the following means that the NIC (network interface card) and the network equipments are set up so that they cannot send and receive at the same time?

- A. Half Duplex
- B. Single Duplex
- C. Paused Duplex
- D. Switched Duplex

Answer: A

Q236. What name does Windows use for a peer to peer network?

- A. Group
- B. Domain
- C. Network
- D. Workgroup

Answer: D

Q237. From which location are first instructions available when a microcomputer is powering up?

- A. CPU
- B. Boot.ini
- C. Config.sys
- D. ROM BIOS

Answer: D

Q238. Which component must be vacuumed or replaced during preventive maintenance of a laser printer?

- A. Ozone filter
- B. Developing Blade
- C. Scanning mirror
- D. Photosensitive Drum

Answer: D

Q239. ISA card should work in which bus slots? (Choose two.)

- A. ISA
- B. PCI
- C. MCA
- D. EISA
- E. AGP

Answer: A, D

Q240. How does a parallel port communicate information to a peripheral device?

- A. 1 bit at a time.
- B. 1 byte at a time.
- C. 8 bytes at a time.
- D. 16,555 bytes at a time.

Answer: B

Q241. What is modified when changing the system start up boot sequence?

- A. BIOS/CMOS
- B. COMMAND.COM
- C. CONFIG.SYS
- D. AUTOEXEC.BAT

Answer: A

Q242. Which type of field replaceable unit is a SCSI host adapter?

- A. CPU
- B. I/O card
- C. Video Card
- D. Hard Drive

Answer: B

Q243. What is the next technology that was added to the Pentium III?

- A. Enhanced audio steaming
- B. Enhanced graphics capabilities
- C. Internet streaming SIMB extensions
- D. MMX4

Answer: C

Q244. Which of the following devices may have the same locking connector? (Choose two.)

- A. VGA monitor
- B. Serial mouse
- C. USB printer
- D. SCSI scanner
- E. Parallel printer

Answer: D, E

Q245. What does a "601" error indicate during POST (Power On Self-Test)?

- A. Hard drive error.
- B. Floppy drive error.
- C. Network boot problem.
- D. Defective power supply.

Answer: B

Q246. Which steps must you take when installing a second IDE on the same IDE controller?

- A. Terminate the second drive properly.

- B. Set the drive identification to match.
- C. Place the boot drive at the end of the IDE cable.
- D. Set one drive as master and other as slave.

Answer: D

Q247. What is a major design difference between Pentium I and Pentium II?

- A. Pipeline cache size
- B. Capacitor technology
- C. Additional instruction set
- D. High-core temperature

Answer: B

Q248. When you configure your hard disk or COM ports in the BIOS, where does the BIOS save this information?

- A. CPU
- B. CMOS
- C. Memory
- D. Hard Drive

Answer: B

Q249. Which type of connectors are used on a parallel printer cable? (Choose two.)

- A. RJ-25
- B. DB25
- C. DB9
- D. MiniDIN
- E. Centronics36

Answer: B, E

DB25: is a parallel printer connection on the PC end.

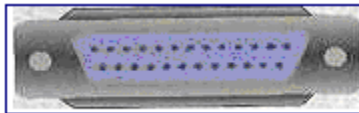

Centronics36: is a parallel printer connection on the printer end.

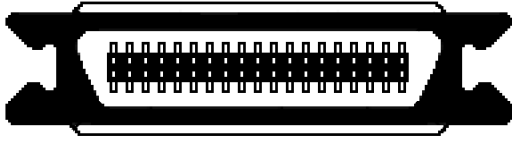

Q250. WRAM (Windows Accelerator Card RAM) is used on a _____ .

- A. Modem
- B. Motherboard
- C. Video card
- D. ATA controller

Answer: C

Q251. In Inkjet printers, what is the most common problem with the paper tray?

- A. In consistent printing.
- B. Misalignment of the sheet feeder.
- C. Paper jamming on the ink cartage.
- D. Malfunctioning pick up rollers.

Answer: D

Q252. What is the first program that runs during a system boot sequence?

- A. BIOS
- B. COMMAND.COM
- C. CONFIG.SYS
- D. AUTOEXEC.BAT

Answer: A

Q253. The CD-ROM does not work on your PC. You suspect that the CD-ROM is not getting the proper voltage. What should you use to test the power connector?

- A. Multimeter
- B. Continuity Tester
- C. Loop back tester
- D. High voltage probe

Answer: A

Q254. The monitor is displaying mostly in green color and not in normal colors. What is the most likely cause of this problem? (Choose two.)

- A. The monitor is defective.

- B. The drivers are installed incorrectly.
- C. The resolution is set too high.
- D. A pin on the connector is bent.
- E. The refresh rate is too fast.

Answer: A, D

Q255. When installing an AT power supply which colors are adjacent on the connector?

- A. Red, Red
- B. Black, Black
- C. Black, Red
- D. Red, Black

Answer: B

Q256. What would cause a keyboard error message? (Choose two.)

- A. Stuck Key.
- B. Pressing the F5 key.
- C. Pressing CTRL + ALT + ESC
- D. Keyboard not plugged in.

Answer: A, D

Q257. Which of the following are the valid translations in the hard drive settings in the CMOS? (Choose three.)

- A. CHS
- B. TRA
- C. LBA
- D. Extended TRA
- E. Extended CHS

Answer: A, C, E

Q258. How many pins are on a VGA connector?

- A. 9
- B. 15
- C. 25
- D. 50

Answer: B

Monitor connector has 3 rows with 5 pins each.



Q259. After installing a sound card the system locks up when a parallel port tape backup is also used. What is the most likely cause of this problem? (Choose two.)

- A. Defective LPT port
- B. Defective Tape Driver
- C. IRQ conflict
- D. DMA conflict
- E. Defective Sound Card

Answer: C, E

Q260. You want to upgrade your BIOS for a particular motherboard. What do you need to know?

- A. Memory Type
- B. Make and Model
- C. Hard Drive Size
- D. DIMM manufacturer

Answer: B

Q261. What would a multimeter be used to measure?

- A. CD-ROM data
- B. Floppy drive speed
- C. Power-supply voltage
- D. RAID controller synchronization

Answer: C

Q262. How many PC Type 3 cards can you insert into a laptop at a single time?

- A. 1
- B. 2
- C. 3
- D. 4

Answer: B

Q263. You have just installed a new IDE hard drive on your PC, but your system BIOS will not recognize the new drive. What should you check first?

- A. Cable sequence.
- B. Drivers that need to be loaded.
- C. Jumpers on the hard drive.
- D. Hard Drive manufacturer Web site information.

Answer: C

Q264. Which is the fastest speed?

- A. 2 ns
- B. 20 ns
- C. 50 ns
- D. 100 ns

Answer: A

The fast speed means the smallest time i.e., 2 nanoseconds.

Q265. What is the proper installation practice for installing DIMMs and RIMMs?

- A. Unplug the PC.
- B. Install modules in pairs.
- C. Use a ground strip.
- D. Leave the power on.

Answer: A

Q266. You have just installed a new internal PCI modem on your desktop. The modem is unable to dial out. What is the most likely cause of this problem?

- A. The port speed is set too high.
- B. The phone line is plugged in to the line in port on the modem card.
- C. The modem has not been set up in control panel properties
- D. The phone line out of the wall is plugged into the PHONE port on the modem card.

Answer: D

Q267. Which processors can fit in the same socket? (Choose three.)

- A. AMD K6
- B. Cyrix MLL
- C. AMD K7
- D. Pentium II
- E. Pentium MMX

Answer: A, B, E

Socket 7 supports late Pentium models including Pentium MMX, AMD K6 (not K7, which is much later), and Cyrix processors.

Q268. What is the highest address that can be referred on a three-position SCSI-2 jumper block?

- A. 4
- B. 7
- C. 8
- D. 15

Answer: B

The highest binary value with three digits is 111, so, conversion to decimal will be $4+2+1=7$.

Q269. What are the benefits of cleaning the interiors of the computer? (Choose two.)

- A. Increase CPU processing speed.
- B. Increase connectivity speed.
- C. Provide better system cooling.
- D. Increase the value of your computer.
- E. Reduce the risk of component failure.

Answer: C, E

Q270. What should you use to extinguish a computer fire?

- A. Fire hose
- B. Class A extinguisher
- C. Class B extinguisher
- D. Class C extinguisher
- E. A silver foam water extinguisher

Answer: D

Q271. Which of the following is the type of IDE transaction?

- A. LBA
- B. UTB
- C. QIC
- D. USB

Answer: A

LBA (Logical Block Addressing): is a translation standard for BIOSs to support IDE drives larger than the old limit of 528 MB.

Q272. You have just installed a new USB printer on your Windows 95 computer, but your PC is unable to recognize it. What is the most likely cause of this problem?

- A. DMA conflicts.
- B. USB cable too short.
- C. IRQ conflict.
- D. USB supplement for Windows 95 is not installed.

Answer: D

Q273. You have installed a new modem with jumpers set to COM2 and IRQ3, but Windows cannot detect the modem. What is the most likely cause of this problem?

- A. No dial tone.
- B. IRQ conflict.
- C. DMA over run.
- D. COM port speed not set to 256 Kbps.

Answer: B

Q274. What should you replace if the brightness or contrast adjustments were malfunctioning on a laptop?

- A. Fuse
- B. LCD Display
- C. LCD display Cable
- D. Adjustment Switch

Answer: D

Q275. A laser printer generates a totally black paper. What is the most likely cause of this problem?

- A. Low level in the tonal cartage.
- B. Malfunctioning image laser.
- C. No power to the transfer corona.
- D. No power to the primary corona.

Answer: D

Q276. What is the paper feeder technology most commonly associated with dot matrix printers?

- A. Sheet feed
- B. Friction feed
- C. Manual feed
- D. Tractor feed

Answer: D

Q277. What are the major hard drive settings in the CMOS? (Choose three.)

- A. Tracks
- B. Volume
- C. Heads
- D. Sector
- E. Cylinder

Answer: C, D, E

Q278. For what particular reasons was MMX technology added to the Pentium II?

- A. Speed up modem access to the internet.
- B. Improve security when using windows 95/98.
- C. Handle multimedia functions like sound and video.
- D. Improve printing speed.

Answer: C

Q279. Which of the following allows you to print on both sides of the paper?

- A. Fuser
- B. Duplexer
- C. Toner cartage
- D. Paper swapping unit

Answer: D

Q280. When installing PCI network interface, you can check the IRQ availability by looking at _____ .

- A. Config.SYS
- B. DIP switches
- C. Jumper settings
- D. Motherboard BIOS

Answer: D

The BIOS or the Device Manager can be used to check IRQ availability.

Q281. How many pins does a standard IDE connector have?

- A. 34
- B. 40
- C. 50
- D. 68

Answer: B

Q282. Which device should not be plugged into a standard UPS?

- A. External modem
- B. An inkjet printer
- C. Laser printer
- D. Any monitor

Answer: C

Q283. What could cause a larger capacity drive to format at lower capacity when you install it in an existing system?

- A. The RAM does not support the larger capacity hard drives.
- B. The BIOS cannot handle the larger capacity drive and formats at the highest recognizable capacity.
- C. The disk repository is full.
- D. The new drive is not Y2K compatible.

Answer: B

Q284. All of the following voltage/current combinations should be considered dangerous, but which of these combinations is the most likely to cause serious injury or death?

- A. 5 volts DC at 100 milli amperes.

- B. 12 volts DC at 200 milli ampere.
- C. 240 volts and DC at 10 milli amperes.
- D. 120 Volts DC at 500 amperes.

Answer: D

Q285. When a bearing in the power supply fan goes out. What should you replace?

- A. Fan
- B. Case
- C. Bearing
- D. Power Supply

Answer: D

Q286. What are advantages of the USB? (Choose three.)

- A. Safety
- B. Security
- C. Speed
- D. Expansion
- E. Ease of configuration

Answer: C, D, E

Q287. Which values are held in the CMOS for hard drive?

- A. Access Speed to data
- B. Drive bay location
- C. Size (Head, Cylinders, Sectors)
- D. Physical dimension of the drive (Height, Width, Depth, Weight)

Answer: C

Q288. A customer calls and says that his computer will not boot. You have determined that no sounds are coming from the system and none of the lights are on.

Which of the following should you take to the site to fix this problem?

- A. CPU
- B. Modem
- C. Video card
- D. Monitor
- E. Power supply

Answer: E

Q289. A customer calls and says that the program applications being displayed on the screen are missing lines, details and other graphics. How should you change the setting to solve this problem?

- A. Reduce hardware graphics acceleration.
- B. Increase hardware graphics accelerations.
- C. Increase the horizontal setting on the monitor.
- D. Decrease the vertical display settings on the monitor.

Answer: A

Q290. What is the maximum cable length (in meters), using 20-gauge twisted-pair shielded cable between two full speed USB devices?

- A. 5
- B. 6
- C. 7
- D. 8

Answer: A

Q291. How much video RAM (VRAM) is needed to display 1024 into 768 at 24-bit color?

- A. 1 MB
- B. 4 MB
- C. 8 MB
- D. 512 KB

Answer: B

Q292. Which of the following are the characteristics of a peer-to-peer network? (Choose two.)

- A. Router
- B. TCP/IP protocol
- C. Limited number of computers involved.
- D. Centralized security and administration.
- E. Computer acting as both client and a server.

Answer: C, E

Q293. What is the default IRQ for COM1?

- A. 2
- B. 3
- C. 4
- D. 5

Answer: C

COM1 and COM3 use IRQ4
COM2 and COM4 use IRQ3

Q294. Which type of a cable is most likely used with RJ-45 connectors to attach computers to the network?

- A. 10Base2
- B. 10Base5
- C. 10BaseT
- D. 10BaseXL

Answer: C

RJ-45 connectors are used with UTP and STP cables. 10BaseT networks use UTP/STP. Coaxial cables are used on thinnet (10Base2) or thicknet (10Base5) networks. Fiber connectors are used on 10BaseXL networks.

Q295. When configuring ISA network interface cards without jumpers or plug and play, what is used to set IRQs?

- A. DMA
- B. COMS
- C. Configuration software
- D. The Operating System

Answer: C

ISA cards need either configuration software or configuration on the physical cards (DIP switches or jumpers).

Q296. From the dot-matrix printer, you print one of your documents, but you can only see the bottom half of the characters. What is the most likely cause of this problem?

- A. Defective print head.
- B. Wrong paper thickness.
- C. Paper text incorrectly on tractor.
- D. Defective home position sensor.

Answer: A

Q297. Which of the following statement is true regarding the installation of USB mouse?

- A. You must first set a DMA channel for the new device.
- B. You can plug it in while the computer is running.
- C. You must first set up a specific IRQ for the device.
- D. You must shut the computer down, plug in the mouse, and restart.

Answer: B

USB devices are detected and installed automatically.

Q298. A NIC (network interface card) that has an ST or SC connector on it is an example of _____ .

- A. IR
- B. Thinnet
- C. Twisted Pair
- D. Thicknet
- E. Fiber Optic

Answer: E

Q299. You are installing a modem on COM3. Which I/O address should you use?

- A. 2E8H
- B. 2F8H
- C. 3E8H
- D. 3F8H

Answer: C

COM1: 3F8H
COM2: 2F8H
COM3: 3E8H
COM4: 2E8H

Q300. What is the default IRQ for the floppy drive controller?

- A. 2
- B. 3
- C. 6
- D. 9

Answer: C

Q301. What are the usable DMA channels? (Choose three.)

- A. 0
- B. 1
- C. 7
- D. 8
- E. 9

Answer: A, B, C

Computers have 8 DMA channels: 0 to 7.

Q302. You find that you have no audio. Which of the following does not apply?

- A. An audio adapter needs hardware resources such as an IRQ.
- B. You should check to see if Windows volume control is up.
- C. The speaker cable is not plugged into the right connection.
- D. The sound card is set to a 66 MHz bus speed.

Answer: D

Sound cards are not configured with bus speeds.

Q303. You have a notebook computer, where the 2.5 inch IDE hard drive will not respond. What should you do to confirm if the problem is in the hard drive or the notebook's IDE interface? (Choose two.)

- A. Boot from a floppy and then run FDISK.
- B. Boot from a CD and then run FDISK.
- C. Using a 2.5 inch to 3.5 inch IDE cable adapter try a 3.5 inch IDE hard drive on the notebook's IDE interface.
- D. Using a 2.5 inch to 3.5 inch IDE cable adapter try a 2.5 inch IDE hard drive on a desktop computer's IDE interface.
- E. After replacing the notebook's motherboard confirm whether the hard drive works.

Answer: C, D

Q304. After an attempt to dial-up to Internet, your mouse pointer freezes. What should you check first in order to solve this problem?

- A. Check for browser updates.
- B. Check for IRQ conflict.
- C. Check to see if the correct mouse driver is loaded.

D. Check to see, if you are still connected to internet.

Answer: B

Q305. Which type of physical topology does 10BaseT Ethernet use?

- A. Bus
- B. Star
- C. Ring
- D. Tree

Answer: B

Q306. How should you clean the ROM media?

- A. Dip it in a diluted cleaner solution, then let it dry.
- B. Set clean mode from the CD properties menu.
- C. Wipe it using circular motions.
- D. Wipe it using center to edge motions.

Answer: A

Q307. Your computer's CMOS information was erased. What should you do first before re-entering the correct settings?

- A. Check the motherboard reset pin.
- B. Test the CMOS battery's voltage level.
- C. Replace the CMOS battery.
- D. Observe the PC for problem recurrence.

Answer: C

Q308. Due to the possibility of brown outs, which of the following will help electronic equipment perform in an interrupted manner? (Choose two.)

- A. Strips
- B. Line conditioners
- C. Extension Cords
- D. Battery backup devices

Answer: B, D

Q309. Where is the firewall typically stored?

- A. CPU

- B. RAM
- C. ROM BIOS
- D. Hard disk

Answer: B

Q310. How many bits wide is the AGP bus?

- A. 8
- B. 16
- C. 32
- D. 64

Answer: C

Q311. A Windows 9x system fails to successfully detect new devices that are added. What should you check first to resolve this problem?

- A. CMOS settings in BIOS for plug and play.
- B. BIOS settings in CMOS for plug and play.
- C. Device manager for DMA assignments.
- D. Plug and play settings in control panel.

Answer: B

Q312. Why can multiple SCSI devices work on the same channel?

- A. The first device is set as master and others are set slave.
- B. Each can be configured with a unique identification number.
- C. Each manufacturer codes its equipment number.
- D. No two devices are made exactly the same.

Answer: B

Q313. What does the system board BIOS manage?

- A. NIC
- B. Modems
- C. Printers
- D. ATA (IDE)

Answer: D

Q314. Which standard parallel cable is used with most of the Inkjet printers?

- A. USB
- B. SCSI3
- C. SERIAL DB 15
- D. IEEE 1284

Answer: D

Q315. The electrical connector between the docking station and a portable computer is:

- A. Manufacturer specific only.
- B. Used as a surge suppressor.
- C. Not propriety but is an industry standard.
- D. Manufacturer and model specific.

Answer: A, B

Q316. Your Laser printer pulls multiple paper sheets at one time. What are the most likely causes for this problem? (Choose three.)

- A. Worn Fuser
- B. Humidity
- C. Improper media
- D. Defective toner cartridge
- E. Worn Separation Pad

Answer: B, C, E

Q317. What are the two possible methods to print a printer self test page? (Choose two.)

- A. Through Operator panel on the printer.
- B. From the Start menu of the task bar.
- C. By pressing the engine control button.
- D. Through the Properties of the printer settings.
- E. By inserting the special test paper.

Answer: A, D

Q318. How many pins are there on a serial port connector? (Choose two.)

- A. 8
- B. 9
- C. 10
- D. 15
- E. 25

F. 29

Answer: B, E

Serial port connectors are either of 9 pins or 25 pins, as shown below.

DB9:



DB25:

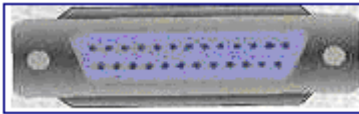

Q319. Which of the following options in the CMOS can be password protected?
(Choose two.)

- A. Modem
- B. Printer
- C. Startup
- D. Screen saver
- E. System setup

Answer: C, E

Q320. How many bits wide is 72 pin non-parity SIMM memory?

- A. 16
- B. 32
- C. 36
- D. 64

Answer: B

Q321. You recently notice that the back of your page comes out dirty on a Laser printer. What is the most likely cause of this problem?

- A. High humidity level.
- B. Light weight paper.
- C. Bad AC power module.
- D. Contaminated fuser.

Answer: D

Q322. While your Inkjet printer is kept idle, what keeps the ink from leaking out of the ink cartridge and onto the paper?

- A. Pump pressure
- B. Electrical current
- C. Maintenance station
- D. Close nozzle gate

Answer: D

Q323. Where is the hard disk information stored?

- A. RAM
- B. CMOS
- C. BOOT.INI
- D. SYSTEM.INI

Answer: B

Q324. On a dot matrix printer which paper type requires tractors to feed the paper?

- A. Single sheets
- B. Envelopes
- C. Fiction Fed
- D. Continuous Forms

Answer: D

Q325. What device must be installed on a computer to provide it with a physical and electrical, and an electronic connection to a network?

- A. Gateway
- B. Router
- C. BNC connector
- D. NIC (network interface card)

Answer: D

Q326. Which motherboard type allows you to turn off the computer via software?

- A. AT
- B. ATX
- C. MCA
- D. VESA

Answer: B

ATX has a soft power switch.

Q327. The maximum distance for a 10BaseT segment is _____ .

- A. 100 meters
- B. 185 meters
- C. 330 meters
- D. 600 meters
- E. 1000 meters

Answer: A

Q328. Which computer port would a digital video camera typically use?

- A. USB
- B. RS-232
- C. IEEE 1284
- D. IEEE 1394 (Fireware port)

Answer: D

Q329. What can a cross over cable in Ethernet be used to do?

- A. Test a faulty network card.
- B. Connect to network devices without a hub.
- C. Convert from 10 Megabits per second to 100 Megabits per second.
- D. Improve bandwidth between the server and the workstations.

Answer: B

Q330. What are the most common SCSI implementations? (Choose two.)

- A. 8-bit Standard SCSI
- B. 16-bit Fast/Wide
- C. 32-bit SCSI-2
- D. 32-bit SCSI-3

Answer: C, D

Q331. When powering on a system, you receive a keyboard error. Which of the following generates this message?

- A. CMS
- B. ASPI
- C. POST
- D. POSIX

Answer: C

Q332. When installing the floppy drive, the A drive letter is established _____ .

- A. through Windows.
- B. by the cable.
- C. by a jumper on the drive.
- D. by a jumper on the motherboard.

Answer: B

Q333. Some users on a 10Base2 network cannot connect to the server. What are the most likely causes of this problem? (Choose two.)

- A. Malfunctioning hub.
- B. Faulty T-connector.
- C. Faulty modular connector on the server NIC.
- D. Server not connected to the hub.
- E. Improperly terminated cable.

Answer: B, E

Q334. What is the smallest storage access unit on an IDE hard drive?

- A. Track
- B. Sector
- C. Cylinder
- D. Partition

Answer: B

Q335. You install a 1.2 GB IDE drive. When you run FDISK, it only reports a drive of 540 MB. What is the most likely cause of this problem?

- A. No active partition is set.
- B. The drive is set to slave.
- C. There is no power to the hard drive.
- D. BIOS/Disk Manager was not updated.
- E. The ribbon cable is on backwards.

Answer: D

Q336. The USB port can supply power for a device. True or False?

- A. True
- B. False

Answer: A

Some USB devices use power from the USB interface, e.g., keyboards.

Q337. Which hardware device on a motherboard can be updated through software?

- A. Data Bus
- B. Chip Set
- C. IDE Controller
- D. System BIOS

Answer: D

The System BIOS can be updated with a Flash BIOS upgrade program resident on a diskette.

Q338. After installing or replacing a hard drive, you try to format but get the following error message: "Invalid media type". What should you run next?

- A. FDISK
- B. CHKDSK
- C. SCANDISK
- D. DISKDIAG

Answer: A

Before formatting a hard drive, the drive must be partitioned. The FDISK utility is used to partition a hard disk.

Q339. To which connector on an IDE cable should you connect the bootable drive?

- A. The first connector from primary IDE controller.

- B. The third connector from the primary IDE controller.
- C. The second connector from the primary IDE controller.
- D. Either the first or the second connector from the primary IDE controller.

Answer: D

The bootable device is not decided by the location on the IDE connector. The active partition will be the bootable drive.

Q340. Which of the following would NOT be repaired onsite?

- A. Faulty video card.
- B. File system errors.
- C. CRT high voltage supply.
- D. Virus infection.

Answer: C

Q341. Which of the following is NOT capable of full-duplex transmission?

- A. USB
- B. Serial
- C. Parallel
- D. IEEE 1394

Answer: B

Q342. What is the newest type of serial bus architecture?

- A. DVD
- B. USB
- C. ATA
- D. ST-506

Answer: B

Q343. The IEEE 1394 is related to which type of bus type?

- A. DMA
- B. SCSI
- C. PS/2
- D. Serial

Answer: D

Q344. Which differentiates EPP (Enhanced Parallel Port) from ECP (Enhanced Capsulation Port) parallel ports?

- A. EPP requires a device driver.
- B. ECP uses 8-bits, EPP uses 4-bits.
- C. EPP requires more RAM.
- D. ECP uses DMA.

Answer: B

Both ECP and EPP use bidirectional communication. EPP only allow communication in one direction i.e., half duplex, while ECP allows simultaneous bi-directional communications i.e., full duplex. ECP is therefore faster than EPP. (ECP uses 8 bits, and EPP uses only 4 bits.)

Q345. What is the name of the process that laser printers use to produce a printed image?

- A. Laser writing
- B. Electro-photographic
- C. Micro-laser printing
- D. Ink-jet laser photographic

Answer: B

Q346. Assuming that the primary and secondary IDE controllers are both enabled, what is the maximum number of devices that can be connected?

- A. 3
- B. 4
- C. 5
- D. 6

Answer: B

Each IDE controller can host 2 IDE devices, so a maximum of four IDE devices could be connected.

Q347. Which of the following CPU is Socket7-based? (Choose all that apply.)

- A. Pentium I
- B. Pentium II
- C. AMD Athlon
- D. Pentium MMX

Answer: A, D

Socket 7 supports late Pentium models including Pentium MMX, AMD K6 (not K7 or AMD Athlon), and Cyrix processors.

Q348. Which set checks the transmitter and receiver of a local modem?

- A. Data-parity
- B. Analog loop back
- C. Local digital loop back
- D. Remote digital loop back

Answer: C

Q349. The ISA bus speed is _____ .

- A. 4.27 MHz
- B. 6 MHz
- C. 8.33 MHz
- D. 16 MHz

Answer: C

Q350. The computer identifies a non maskable interrupt error. What is the most likely cause of this error?

- A. Defective RAM
- B. Lost clusters
- C. Corrupted software
- D. The I/O controller

Answer: A

A non maskable interuppt indicates a hardware error (not lost clusters or corrupted software.)

Q351. Click the area on the graphic that shows the ISA slots on the motherboard. (Refer the graphic given below.)



ISA Slots

Q352. Click the area on the graphic that shows the RJ-45 connector. (Refer the graphic given below.)



Q353. Click the area on the graphic that shows the RJ-11 connector. (Refer the graphic given below.)

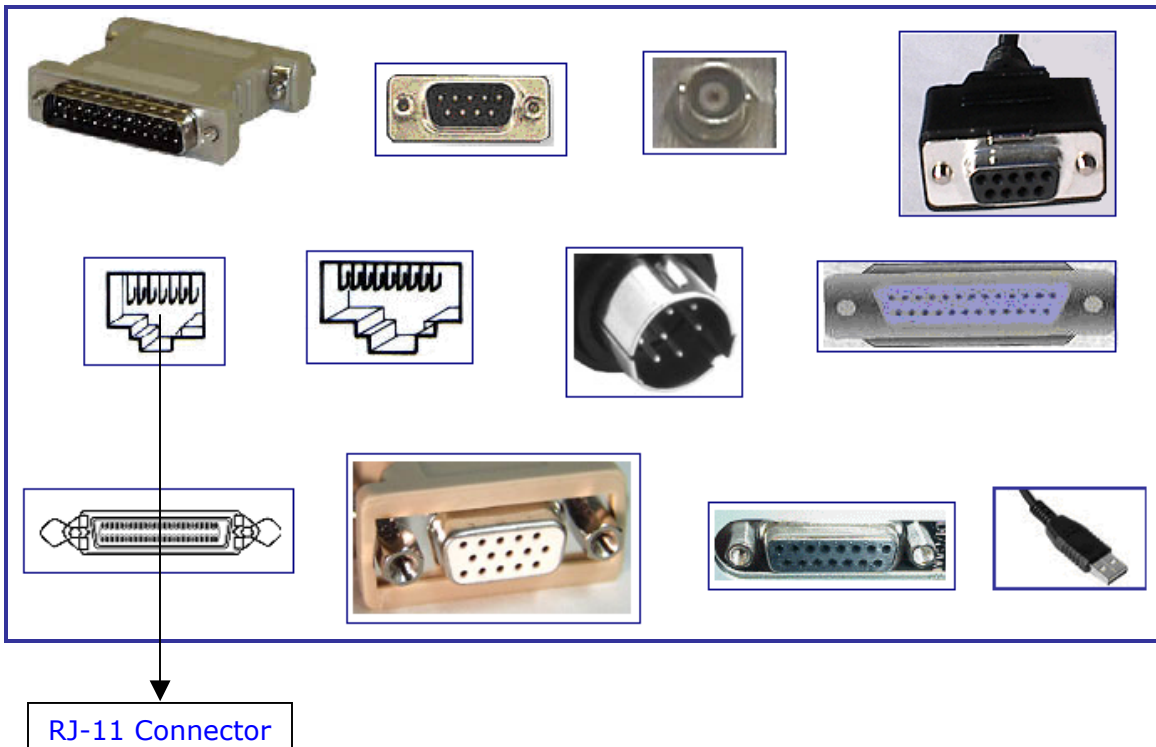

Q354. Identify the motherboard type shown in the graphic. (Refer the graphic given below.)

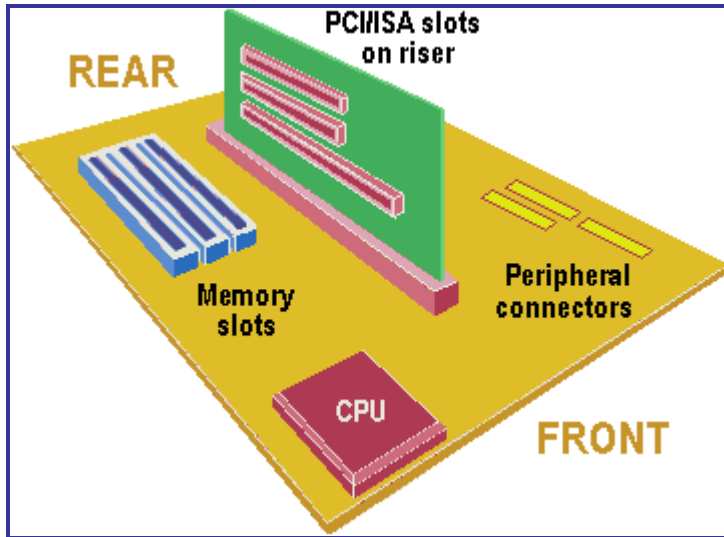

- A. XT
- B. ATX
- C. Full AT
- D. Baby AT

Answer: D

Q355. Click the area on the graphic that shows the BNC connector. (Refer the graphic given below.)

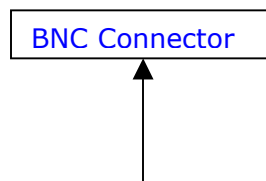

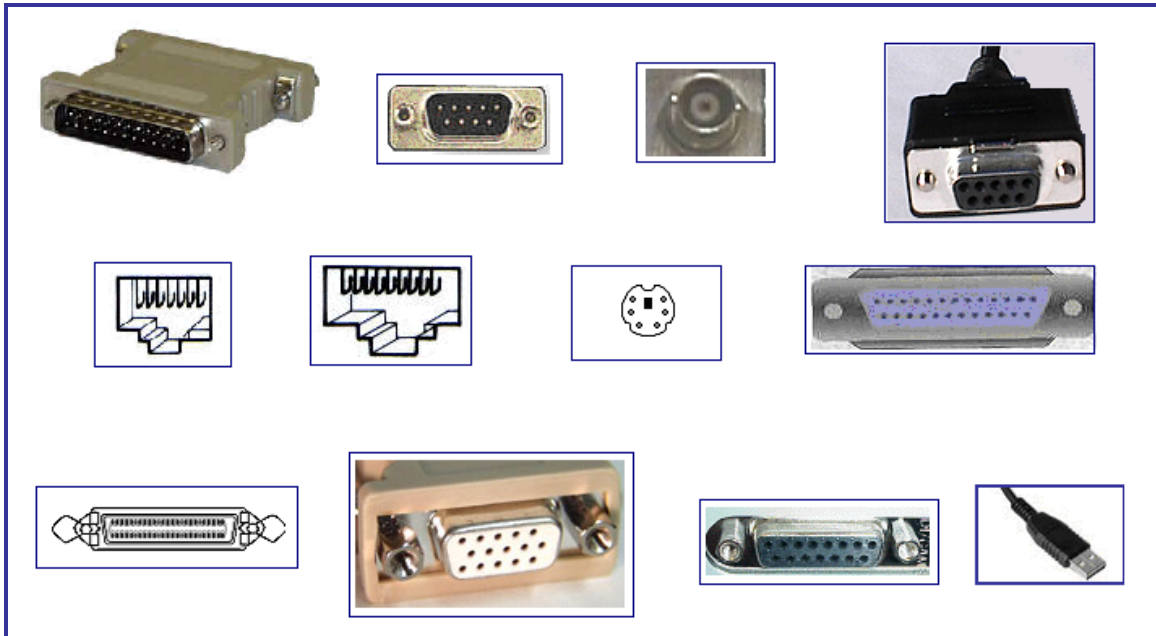

Q356. Click the area on the graphic that shows the sound card speaker connection.
(Refer the graphic given below.)

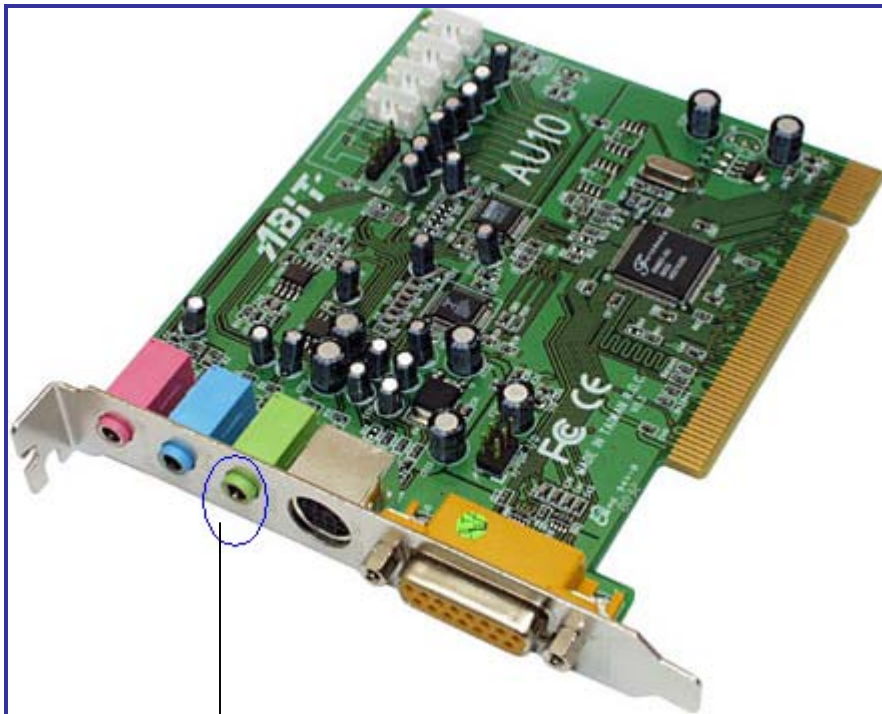

Sound Card Speaker Connection

Q357. Identify the memory module shown in the graphic given below. (Refer the graphic given below.)



- A. 168-pin SIMM
- B. 168-pin DIMM
- C. 30-pin SIMM
- D. 72-pin SIMM

Answer: D

Q358. Identify the memory module shown in the graphic given below. (Refer the graphic given below.)



- A. SIMM
- B. DIMM
- C. 30-pin SIMM

D. 72-pin SIMM

Answer: C

Q359. Click the area on the graphic that shows the COM port connector. (Refer the graphic given below.)

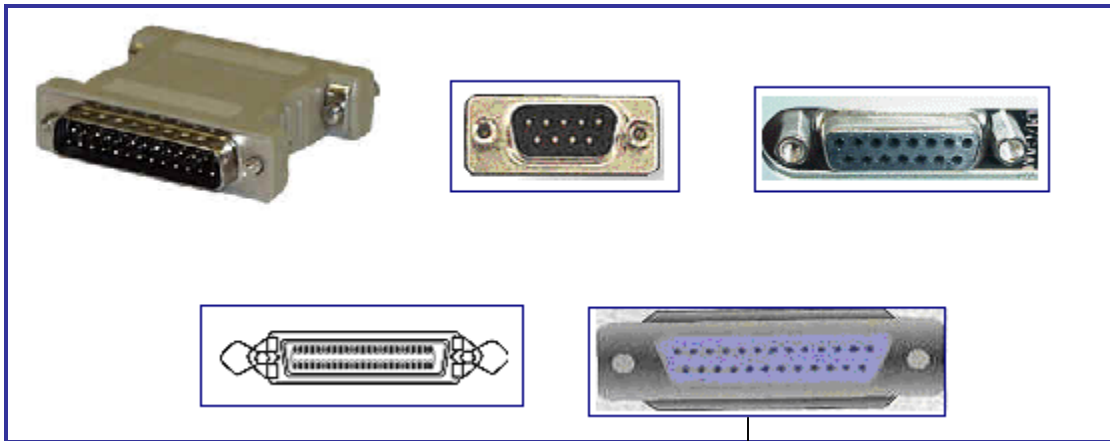

COM Port Connector

Q360. Click the area on the graphic that shows the mini DIN connector. (Refer the graphic given below.)

Mini DIN Connector

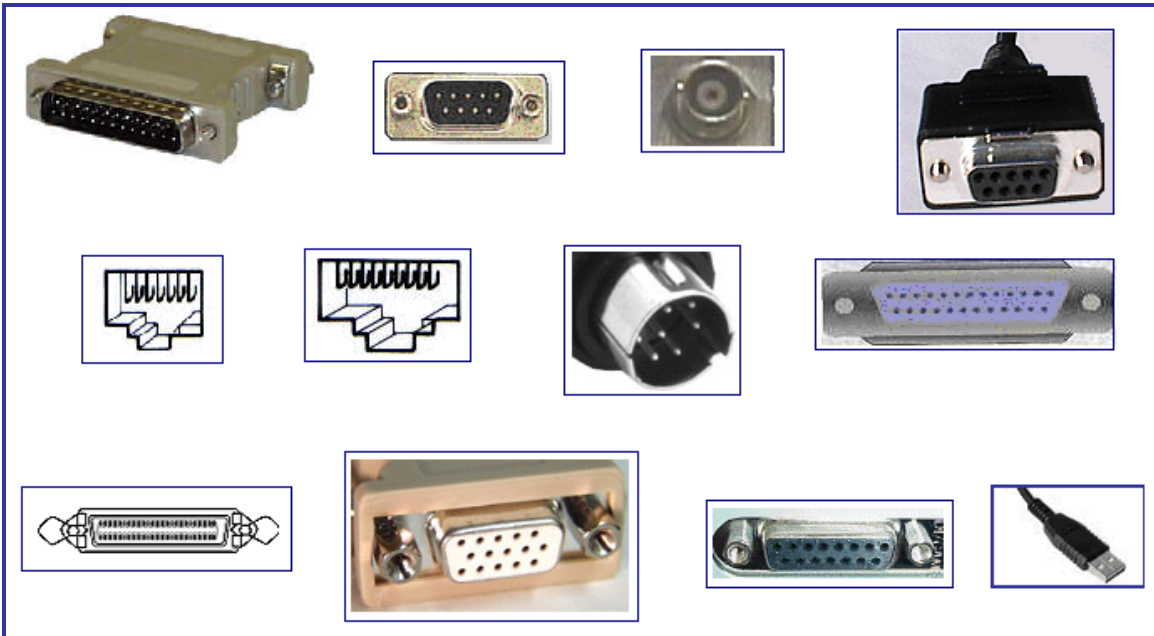

(Note: Mini DIN connector is similar to PS/2 mouse connector and is used for connecting a keyboard to a computer.)

Q361. Click the area on the graphic that shows the ethernet cable connector. (Refer the graphic given below.)

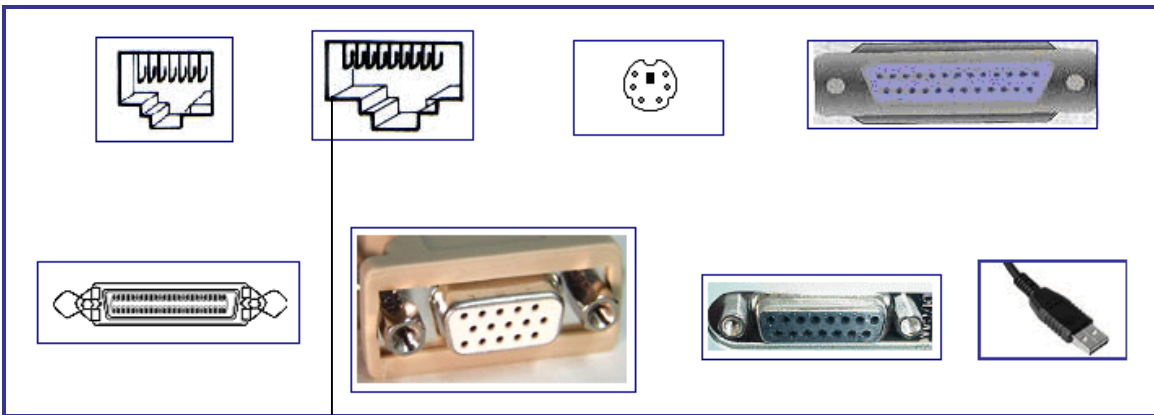

RJ-45 connector
(used as an ethernet cable connector)

Q361. Click the area on the graphic that shows the ethernet cable connector. (Refer the graphic given below.)

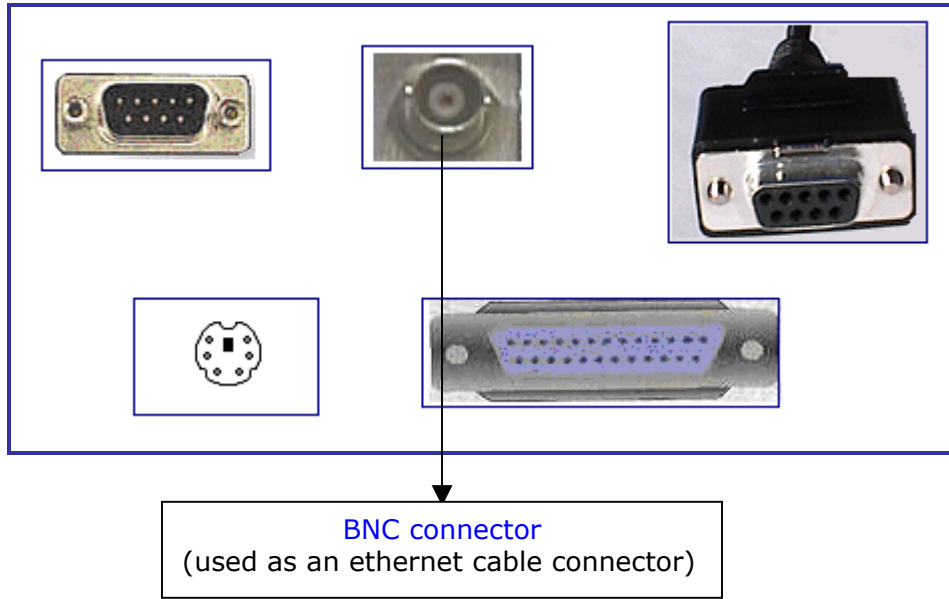

Q363 . Click the area on the graphic that shows the PCI slots on the motherboard.
(Refer the graphic given below.)

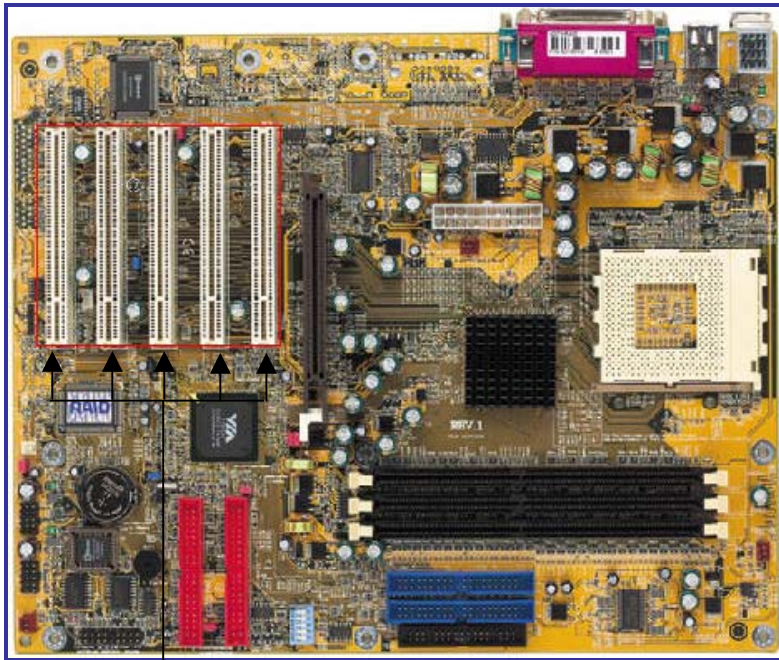

Q364 **PCI Slots** area on the graphic that shows the place to connect a telephone line to the modem. (Refer the graphic given below.)



Connect a telephone line here

Q365. Click the area on the graphic that shows the monitor connector. (Refer the graphic given below.)

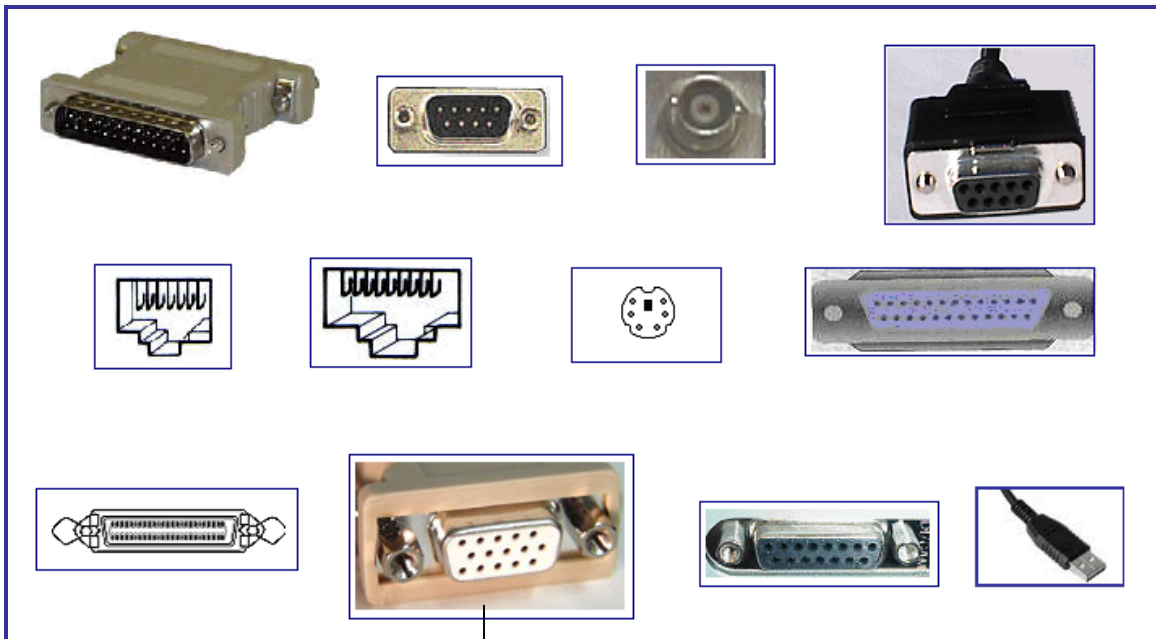

Monitor Connector

Q366. Click the area on the graphic that shows the Floppy port on the motherboard. (Refer the graphic given below.)

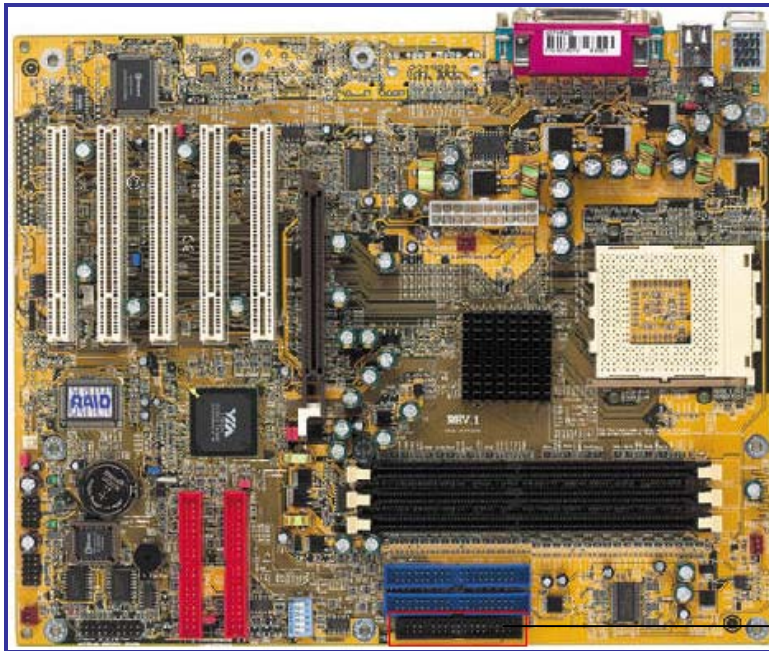

Floppy Port

Q367. Click the area on the graphic that shows the DIMM slot on the motherboard. (Refer the graphic given below.)

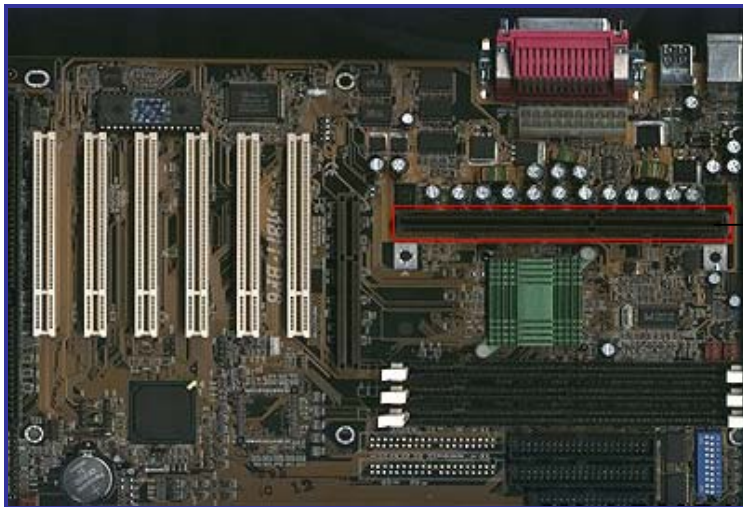

DIMM Slot

Q368. Click the area on the graphic that shows the printer port connector. (Refer the graphic given below.)

Printer Port Connector



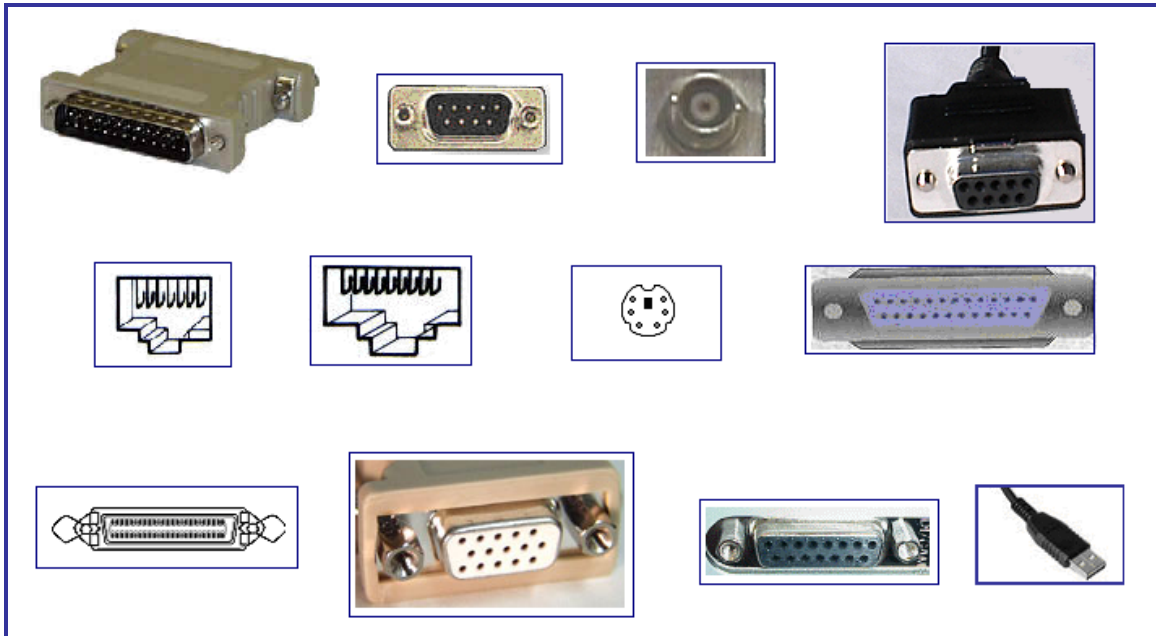

Q369. Click the area on the graphic that shows the joystick connector. (Refer the graphic given below.)

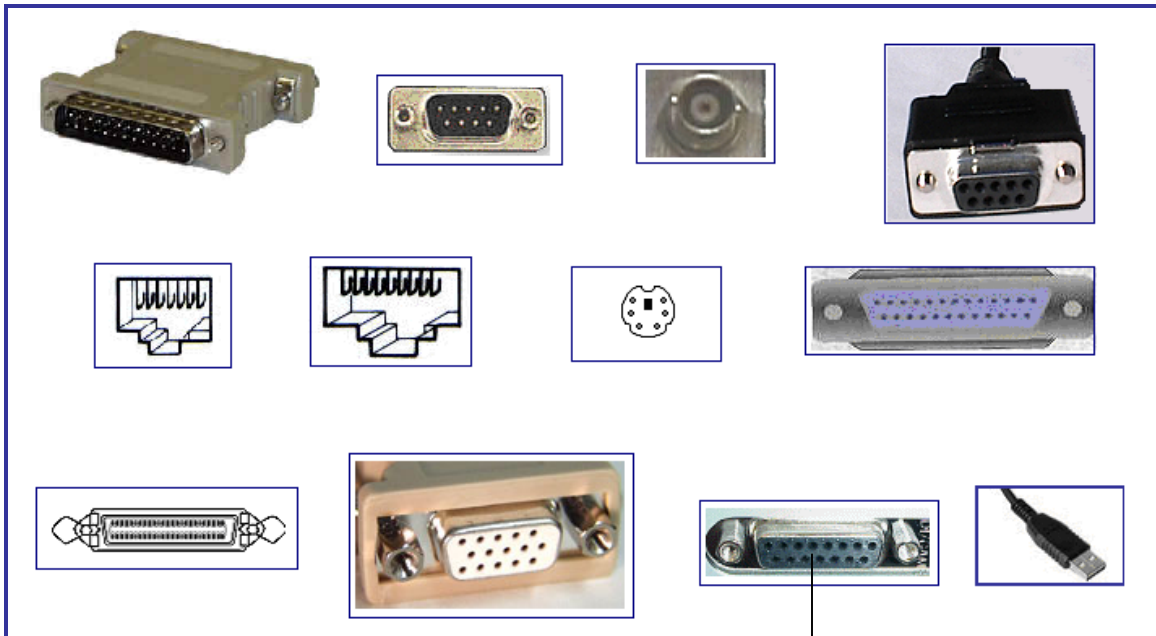

Joystick Connector

Q370. Click the area on the graphic that shows the

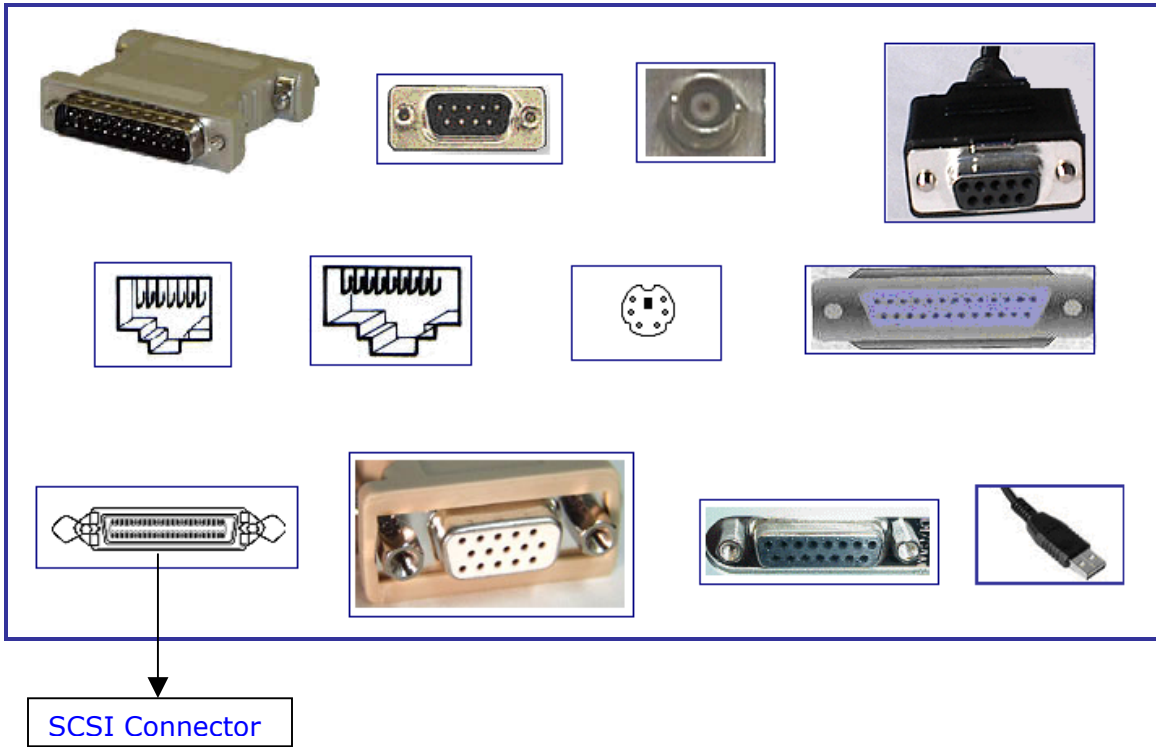

Q371. Click the area on the graphic that shows the USB connector.

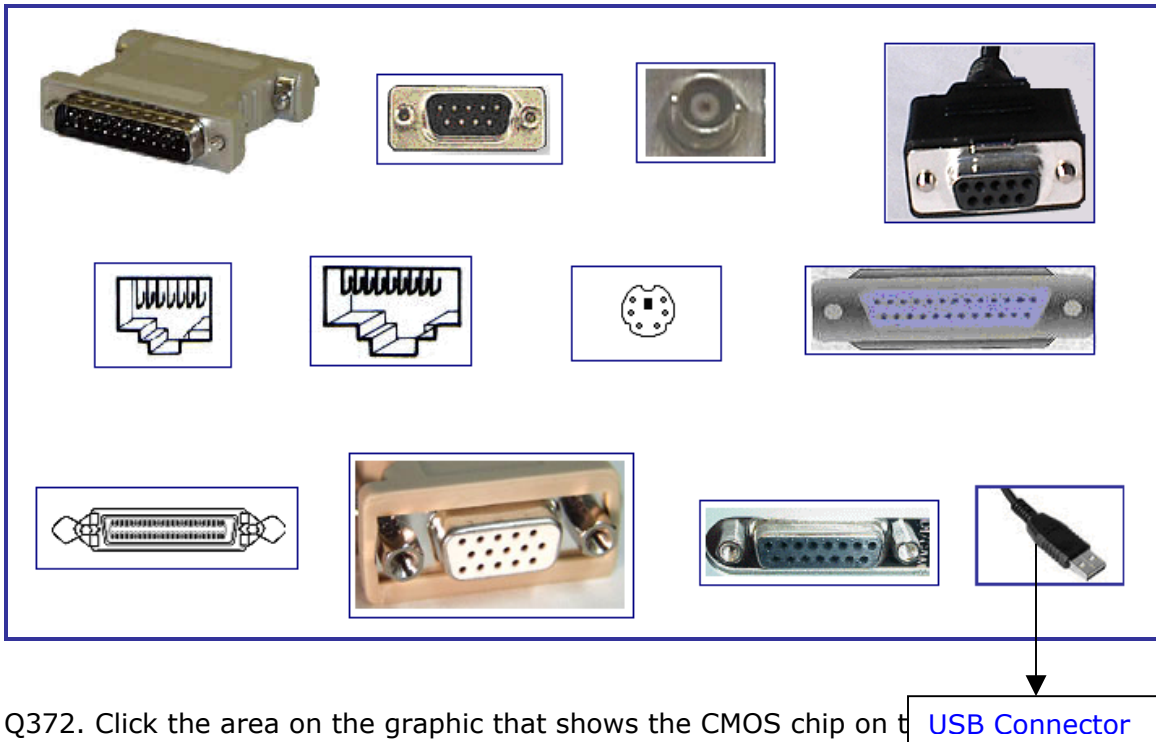

Q372. Click the area on the graphic that shows the CMOS chip on the

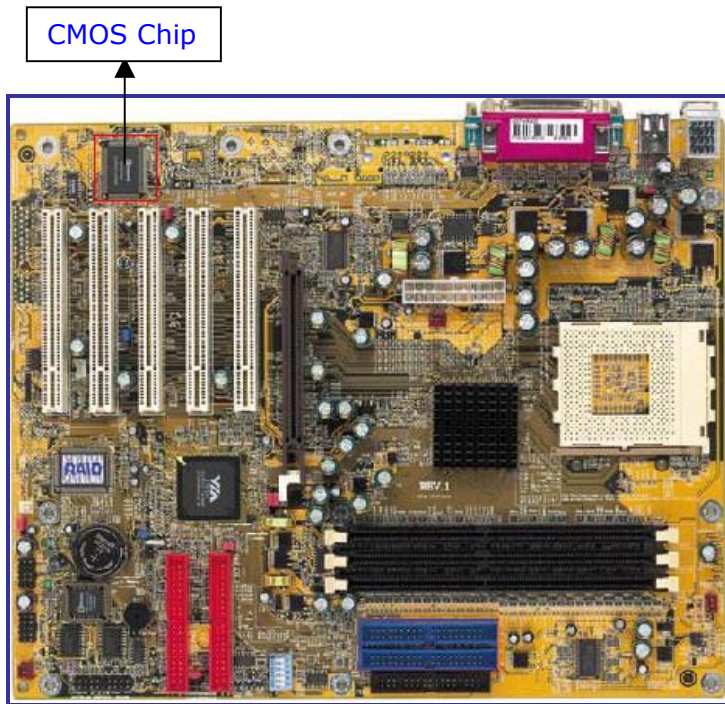

Q373. Click the area on the graphic that shows the Keyboard connector on the motherboard.

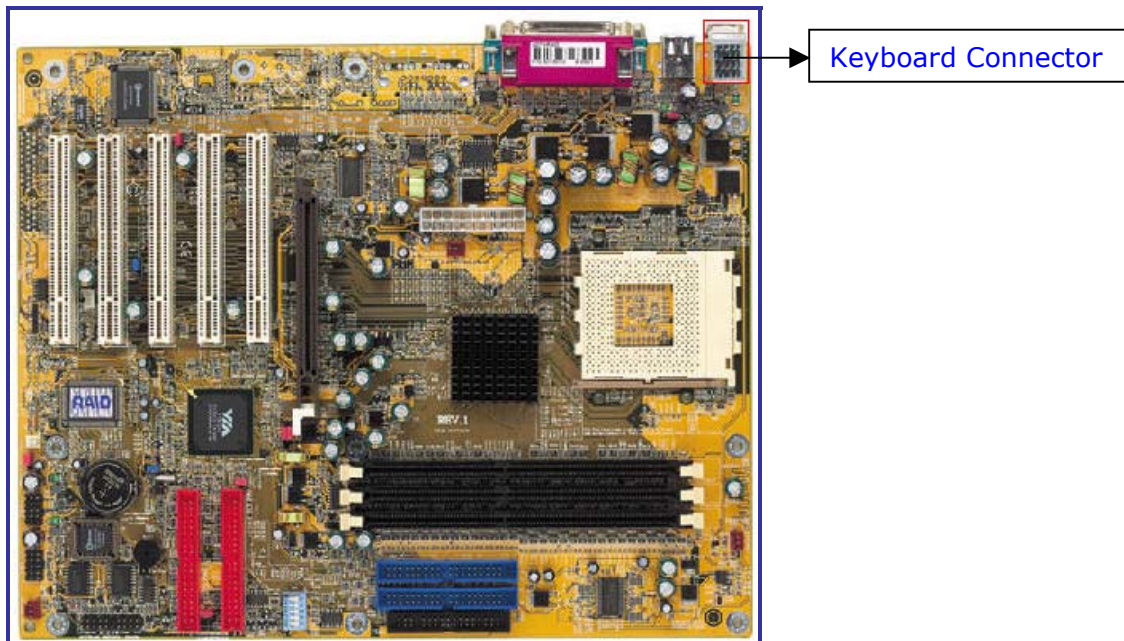

Q374. Click the area on the graphic that shows the PS/2 mouse connector.

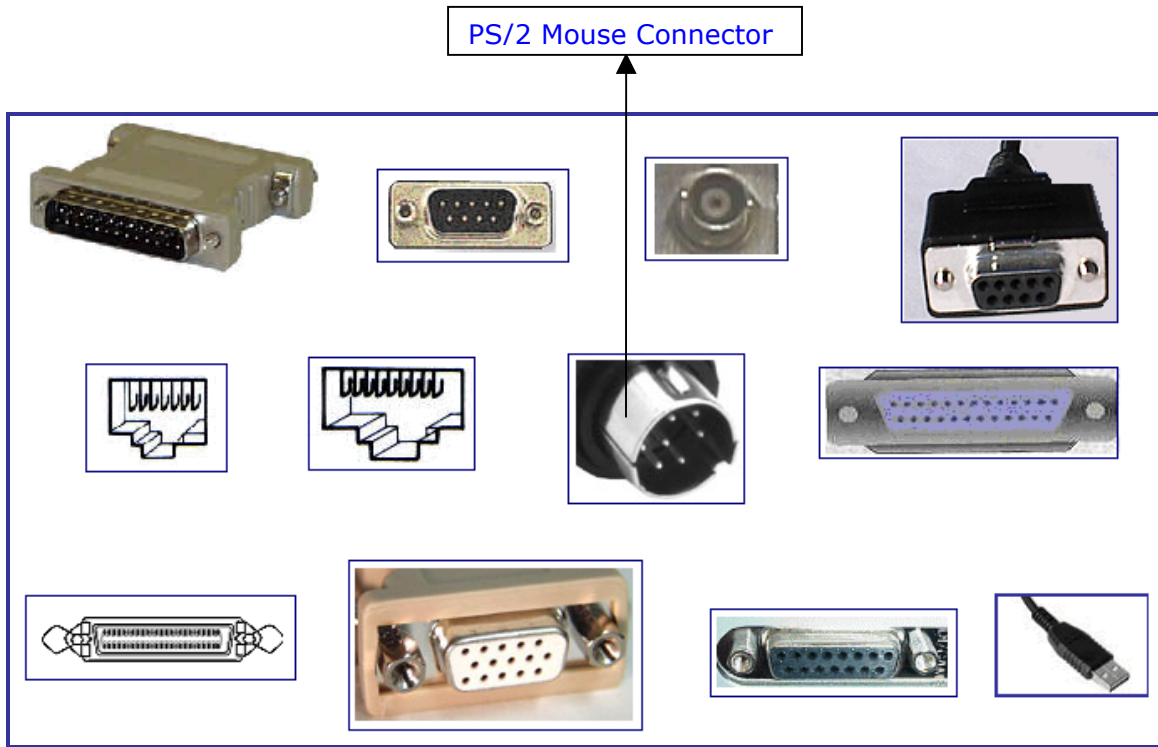

Q375. Click the area on the graphic that shows the IDE ports on the motherboard.

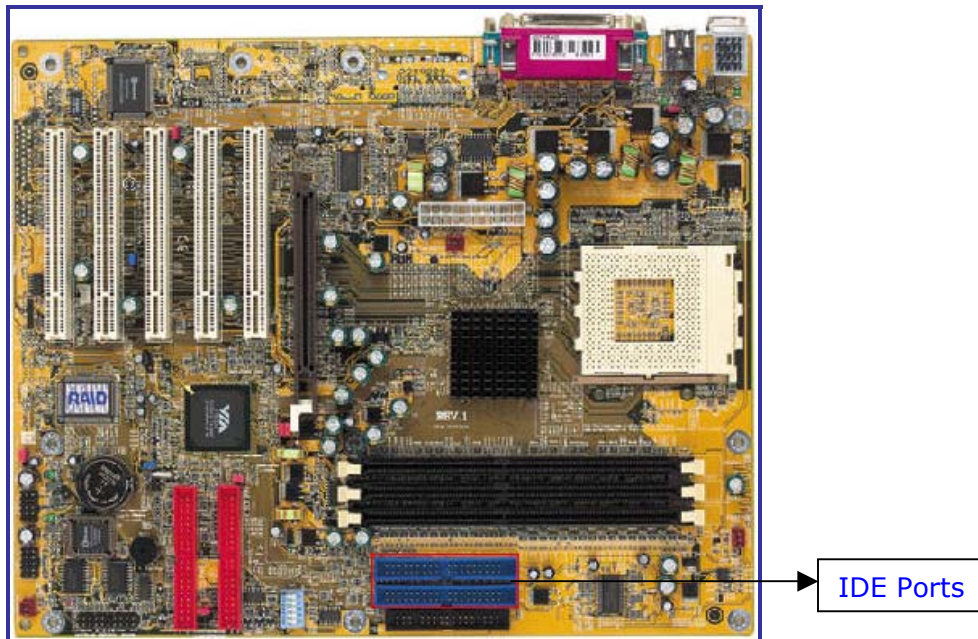

Q376. Click the area on the graphic that shows the Power connector on the motherboard. (Refer the graphic given below.)

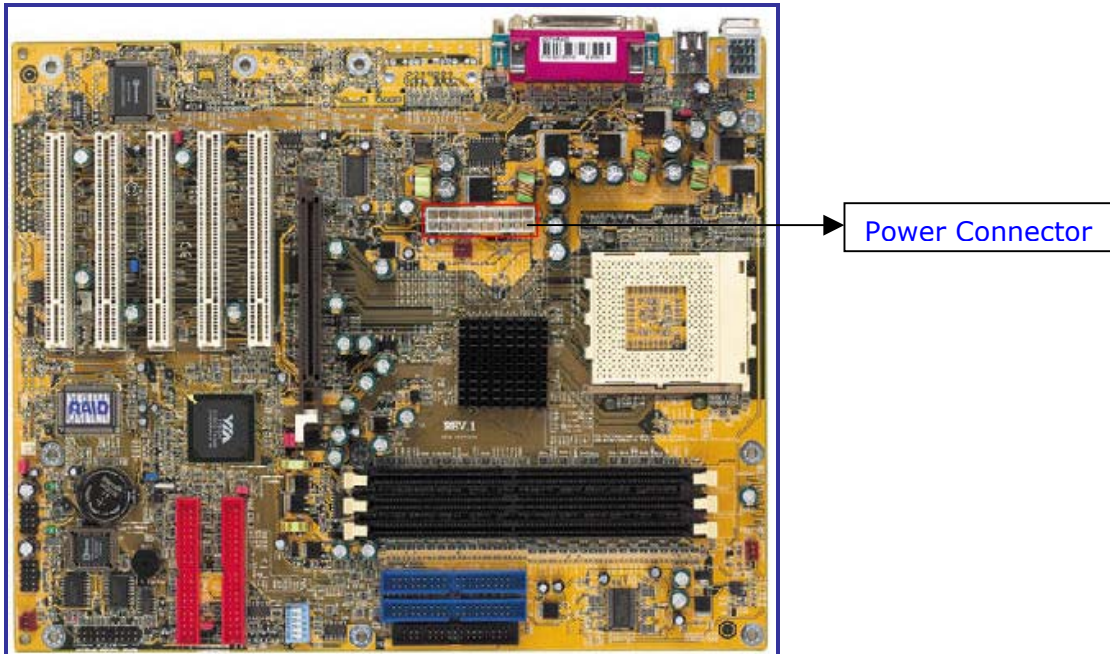

Q377. Click the area on the graphic that shows the AGP slot on the motherboard. (Refer the graphic given below.)

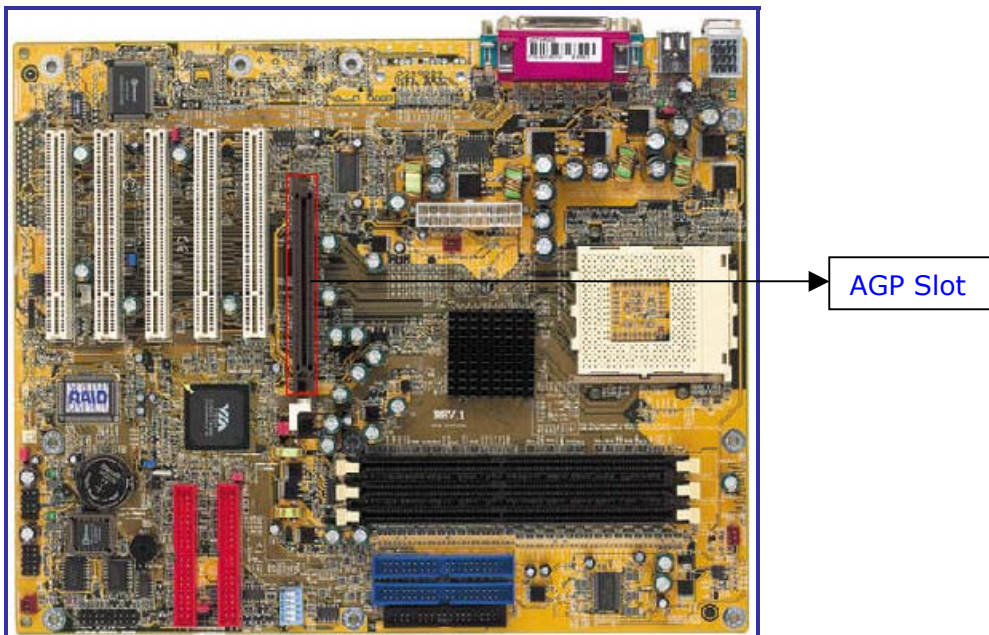

Q378. Click the area on the graphic that shows the CPU slot on the motherboard.

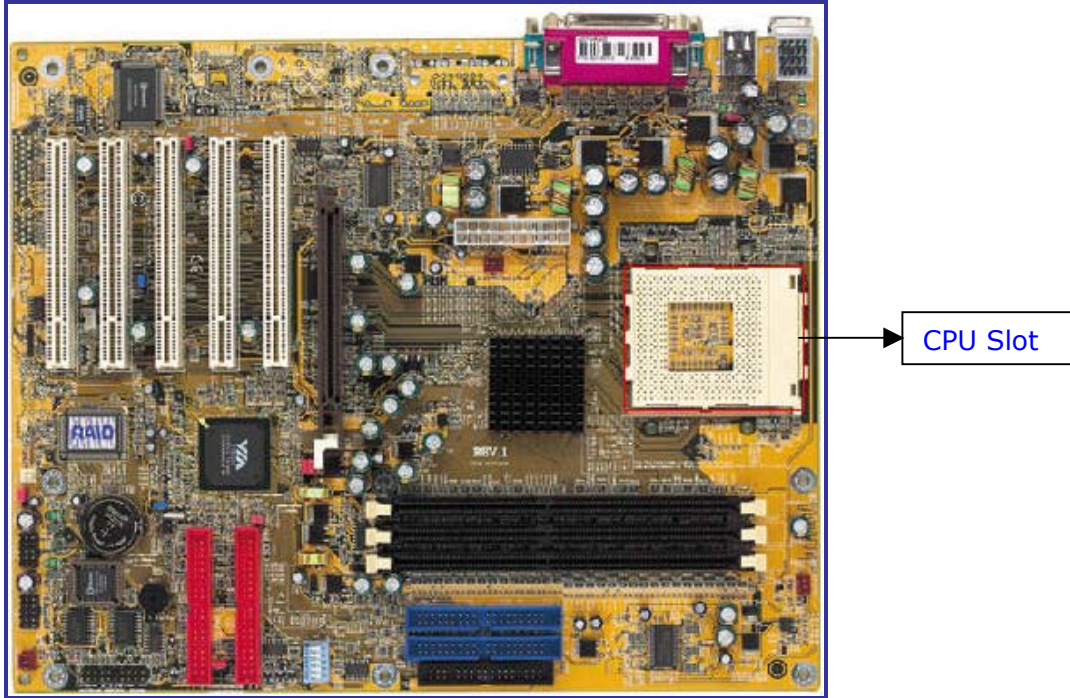

Q379. Click the area on the graphic that shows the SIMM slot on the motherboard.

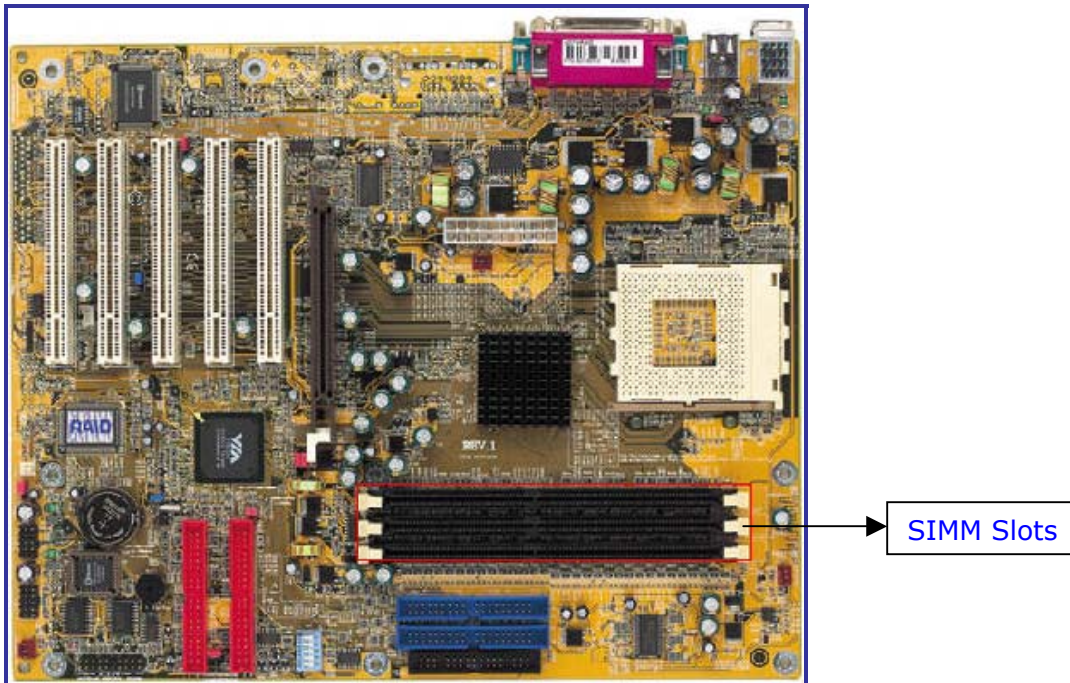

Q380. Click the area on the graphic that shows the COM port connector. (Refer the graphic given below.)

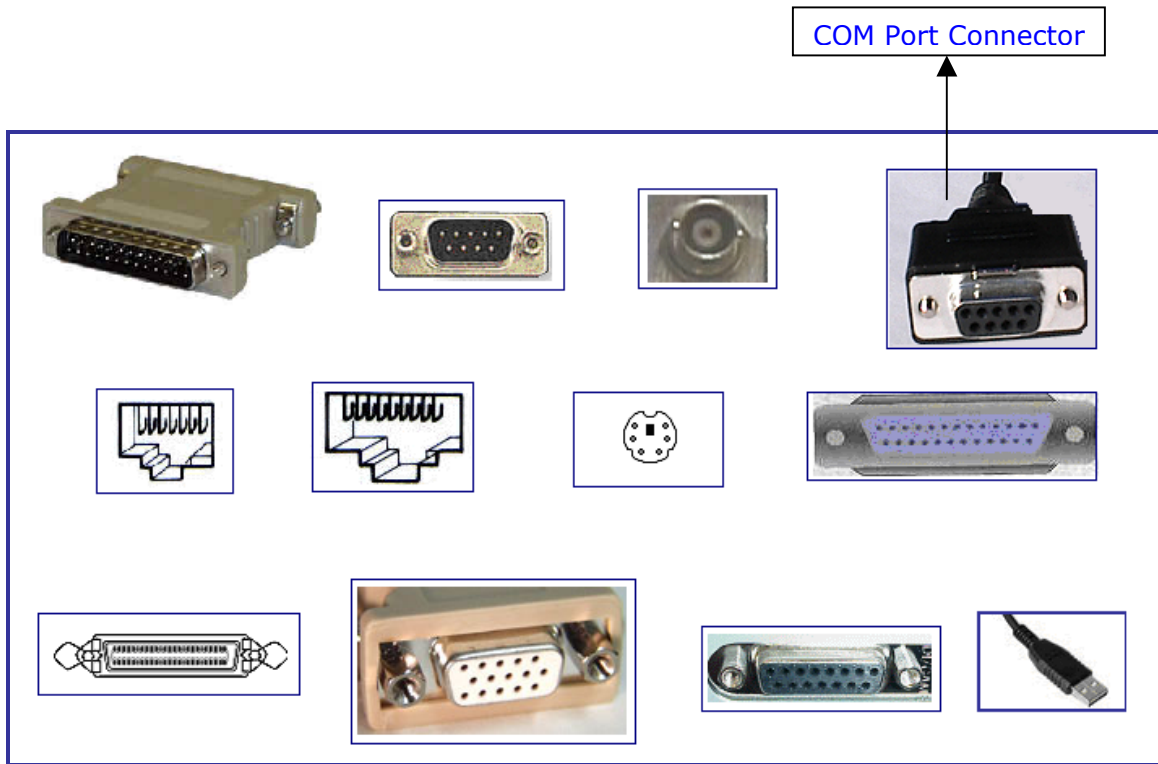

(Note: If you are given both the 9-pin COM port and the 25-pin COM port in the graphic, then click the 9-pin COM port graphic as your answer, since 9-pin COM port is the most preferred one.)

Q381. Identify the type of motherboard shown in the graphic given below.

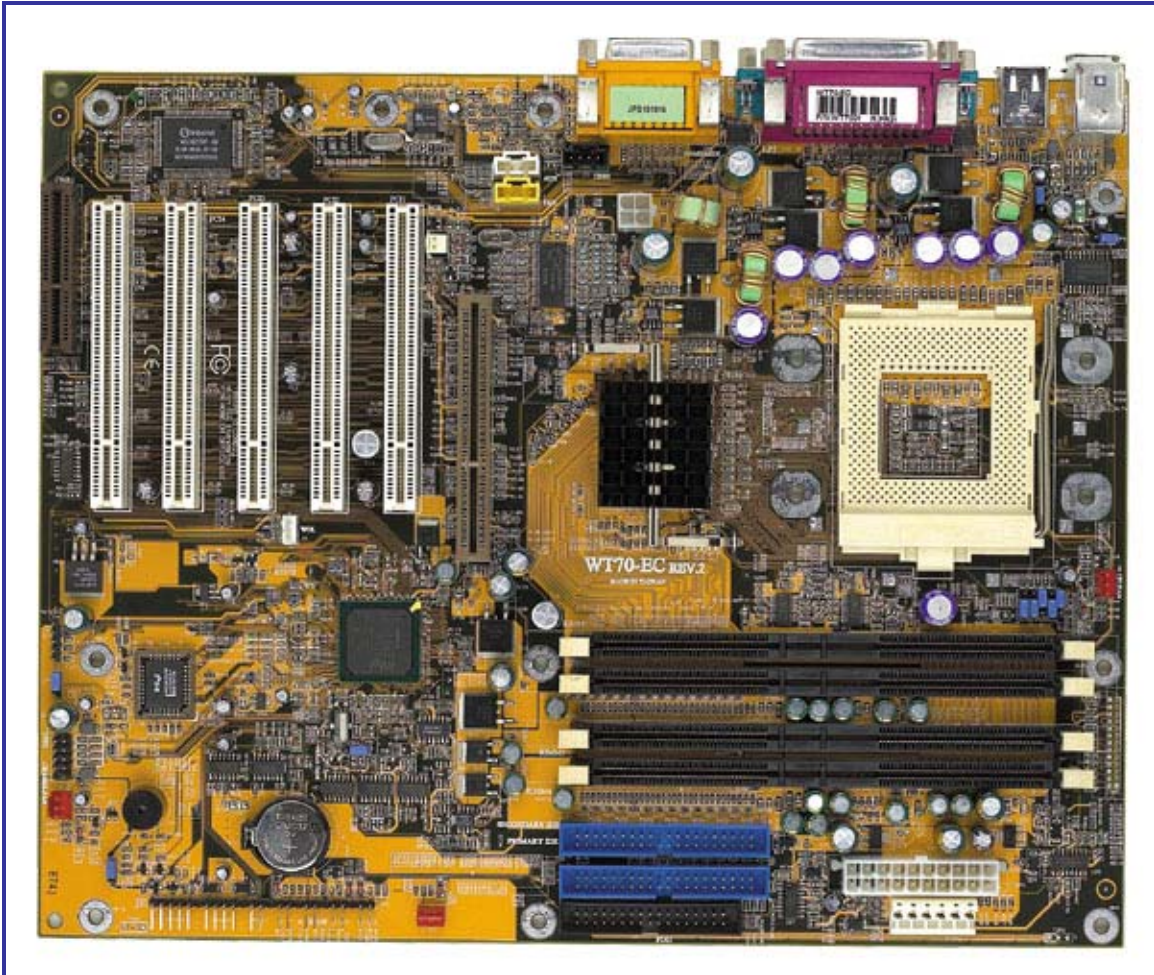

- A. XT
- B. ATX
- C. Full AT
- D. Baby AT

Answer: B

Q382. Which device is needed to extend a 10Base2 network beyond the maximum segment distance?

- A. Extender
- B. Repeater
- C. Converter
- D. Expander

Answer: B

Q383. After you take a page out of the laser-jet printer, the print looks good but smears when you pick up the paper. What is the problem?

- A. Damp paper
- B. Fuser assembly
- C. Wrong type of toner
- D. Output roller assembly

Answer: A

Q384. How many 168-pin Dimms are required per memory bank?

- A. 1
- B. 2
- C. 6
- D. 8

Answer: A

-----End of the PDF-----