

Summary of Well Known Interface Standards

National Semiconductor
Application Note 216
John Goldie
July 1998



FORWARD

Designing an interface between systems is not a simple or straight-forward task. Parameters that must be taken into account include: data rate, data format, cable length, mode of transmission, termination, bus common mode range, connector type, and system configuration. Noting the number of parameters illustrates how complex this task actually is. Additionally, the interface's compatibility with systems from other manufacturers is also critically important. Thus, the need for standardized interfaces becomes evident. Interface Standards resolve both the compatibility issue, and ease the design through the use of non-custom standardized Drivers and Receivers.

INTRODUCTION

This application note provides a short summary of popular Interface Standards. In most cases, a table of the major electrical requirements and a typical application is illustrated. Interface Standards from the following standardization organizations are covered in this application note:

- TIA/EIA Telecommunications Industry Association/ Electronics Industry Association
- ITU International Telecommunications Union
- CCITT International Telegraph and Telephone Consultative Committee — now replaced by the ITU
- MIL-STD United States Military Standards
- FED-STD Federal Telecommunications Standard Committee
- Other selected interface standards

There are two basic modes of operation for line drivers (generators) and receivers. The two modes are Unbalanced (Single-ended) and Balanced (Differential).

UNBALANCED (SINGLE-ENDED) DATA TRANSMISSION

Unbalanced data transmission uses a single conductor, with a voltage referenced to signal ground (common) to denote logical states. In unbalanced communication only one line is switched. The advantage of unbalanced data transmission is

when multiple channels are required, a common ground can be used (see *Figure 1*). This minimizes cable and connector size, which helps to minimize system cost. The disadvantage of unbalanced data transmission is in its inability to reliably send data in noisy environments. This is due to very limited noise margins. The sources of system noise can include externally induced noise, cross talk, and ground potential differences.

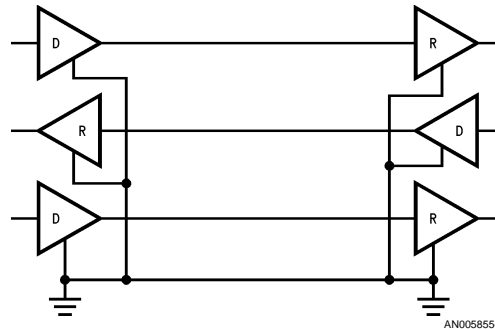

FIGURE 1. Unbalanced Data Transmission- 3 Channel, 4 Line

BALANCED (DIFFERENTIAL) DATA TRANSMISSION

Balanced data transmission requires two conductors per signal. In balanced communication two lines are switched. The logical states are referenced by the difference of potential between the lines, not with respect to ground. This fact makes differential drivers and receivers ideal for use in noisy environments (See *Figure 2*). Differential data transmission nullifies the effects of coupled noise and ground potential differences. Both of these are seen as common mode voltages (seen on both lines), not differential, and are rejected by the receivers. In contrast to unbalanced drivers, most balanced drivers feature fast transition times allowing for operation at higher data rates.

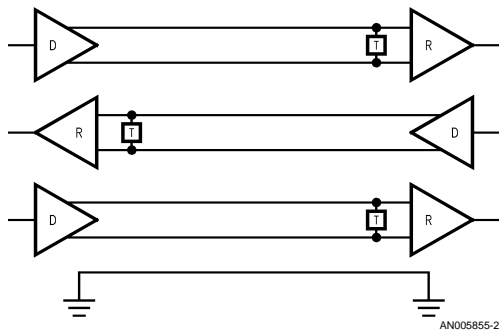

FIGURE 2. Balanced Data Transmission- 3 Channel, 7 Line and Ground

TIA/EIA DATA TRANSMISSION STANDARDS

The Electronic Industry Association (EIA) and the Telecommunications Industry Association (TIA) are industry trade associations that have developed standards to simplify interfaces in data communication systems. The standards are intended for use in Data Terminal Equipment/Data Circuit-terminating Equipment (DTE/DCE) Interfaces. The classic example of the DTE/DCE interface is the "terminal to modem serial interface". However, the standards are not limited to use in DTE/DCE interfaces alone. In fact, many of the standards are commonly used in a wide variety of applications. Examples include Hard Disk Drive Interfaces, Factory Control Busses, and generic I/O Busses. Previously, EIA labeled the standards with the prefix "RS", which stood for recommended standard. This has been replaced with "TIA/EIA", to help in identifying the source of the standard. The letter suffix represents the revision level of the standard. For example, TIA/EIA-232-E represents the fifth revision of RS-232.

TIA/EIA Data Transmission Standards cover the following areas: Complete Interface Standards, Electrical Only Standards, and Signal Quality Standards. Complete standards define functional, mechanical, and electrical specifications. Electrical only standards, as their name implies only defines electrical specifications. They are intended to be referenced by complete standards. Signal Quality Standards define terms and methods for measuring signal quality. Examples of each type are listed below.

- Complete DTE/DCE Interface Standards

TIA/EIA-232-F
 TIA/EIA-530-A
 TIA/EIA-561
 TIA/EIA-574
 TIA/EIA-613
 TIA/EIA-687
 TIA/EIA-688
 TIA/EIA-723

- Electrical Only Standards
- Unbalanced Standards
 - TIA/EIA-232-F (Section 2)
 - TIA/EIA-423-B
 - TIA/EIA-562
 - TIA/EIA-694
- Balanced Standards
 - TIA/EIA-422-B
 - TIA/EIA-485-A
 - TIA/EIA-612
 - TIA/EIA-644
- Signal Quality Standards
 - EIA-334-A
 - EIA-363
 - EIA-404-A

TIA/EIA — UNBALANCED (SINGLE-ENDED) STANDARDS

TIA/EIA-232-F (RS-232)

TIA/EIA-232-F is the oldest and most widely known DTE/DCE Interface Standard. It is a complete standard specifying the mechanical (connector(s)), electrical (driver/receiver characteristics), and functional (definition of circuits) requirements for a serial binary DTE/DCE Interface. Under the electrical section, the standard specifies an unbalanced, unidirectional, point-to-point interface. The drivers feature a controlled slew rate, this allows the cable to be seen as a lumped load, rather than a transmission line. This is due to the fact that the driver's transition time is substantially greater than the cable delay (velocity x length). The maximum capacitive load seen by the driver is specified at 2,500 pF. The standard allows for operation up to 20 kbps (19.2 kbps). For higher data rates TIA/EIA-562 or TIA/EIA-423-B are recommended. *Figure 3* illustrates a typical application, and *Table 1* lists the major electrical requirements.

Key Features of the standard are:

- Single-Ended
- Point-to-Point Interface
- Large Polar Driver Output Swing
- Controlled Driver Slew Rate
- Fully Defined Interface
- 20 kbps Maximum Data Rate

TABLE 1. TIA/EIA-232-F Major Electrical Specifications

Parameter	Limit & Units
Driver Loaded Output Voltages (3 kΩ)	≥ 5.0V
Driver Open Circuit Voltage	≤ 25V
Driver Short Circuit Current	≤ 100 mA
Maximum Driver Slew Rate	≤ 30 V/μs
Driver Output Resistance (Power Off)	≥ 300Ω
Receiver Input Resistance	3 kΩ to 7 kΩ
Maximum Receiver Input Voltage	±25V
Receiver Thresholds	±3V

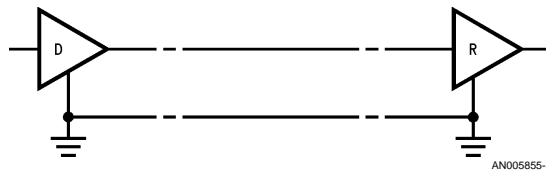

FIGURE 3. Typical TIA/EIA-232-F Application

TIA/EIA-423-B

TIA/EIA-423-B while similar to TIA/EIA-232-F features a reduced driver output swing, and supports higher data rates. This standard specifies an unbalanced driver and a balanced receiver. It is an electrical standard, specifying driver and receiver requirements only. The receivers' requirements are identical to the receivers' requirements specified in TIA/EIA-422-B standard. TIA/EIA-423-B is intended to be referenced by complete standards, such as TIA/EIA-530-A. TIA/EIA-423-B specifies a unidirectional, multidrop (up to ten receivers) interface. Advantages over TIA/EIA-232-F include: multiple receiver operation, faster data rates, and common power supplies (typically $\pm 5V$). Figure 4 illustrates a typical application, and Table 2 lists the major electrical requirements.

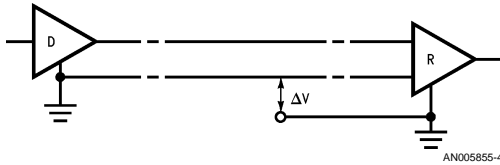

FIGURE 4. Typical TIA/EIA-423-B Application

Key Features of the standard are:

- Unbalanced Driver and Balanced Receivers
- Multi-Drop (multiple receivers)
- Wave Shape Control (Driver Output)
- $\pm 7V$ Receiver Common Mode Range
- ± 200 mV Receiver Sensitivity
- 100 kbps Maximum Data Rate (@40 feet)
- 4000 Foot Maximum Cable Length (@ 1 kbps)

TABLE 2. TIA/EIA-423-B Major Electrical Specifications

Parameter	Limit & Units
Driver Output Voltage (450 Ω Load)	$\geq 3.6V $
Driver Open Circuit Voltage	$\geq 4.0V $ & $\leq 6.0V $
Driver Short Circuit Current	≤ 150 mA
Transition Time	Controlled
Driver Output Leakage Current	≤ 100 μ A
Receiver Specifications	See TIA/EIA-422-B

TIA/EIA-562

TIA/EIA-562 is a electrical standard which is very similar to TIA/EIA-232-F, but supports higher data rates (64 kbps). It is an electrical only standard, which is intended to be referenced by complete standards, such as TIA/EIA-561. TIA/EIA-562 specifies an unbalanced, unidirectional, point-to-point interface. This standard supports inter-operability with TIA/EIA-232-F devices. Figure 5 illustrates a typical application, and Table 3 lists the major electrical requirements.

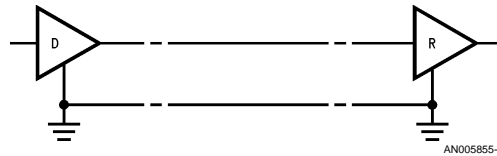

FIGURE 5. Typical TIA/EIA-562 Application

Key Features of the standard are:

- Unbalanced Driver and Receiver
- Point-to-Point
- Inter-Operability with TIA/EIA-232-F Devices
- 64 kbps Maximum Data Rate

TABLE 3. TIA/EIA-562 Major Electrical Specifications

Parameter	Limit & Units
Driver Loaded Output Voltage (Min. Level)	$\geq 3.3V $
Driver Open Circuit Output Voltage	$\leq 13.2V $
Driver Loaded Output Voltage (3 k Ω)	$\geq 3.7V $
Driver Short Circuit Current	≤ 60 mA
Driver Transition Time	Controlled
Maximum Driver Slew Rate	≤ 30 V/ μ s
Driver Output Resistance (Power Off)	$\geq 300\Omega$
Receiver Input Resistance	3 k Ω to 7 k Ω
Maximum Receiver Input Voltage	$\pm 25V$
Receiver Thresholds	$\pm 3V$

TIA/EIA-694

TIA/EIA-694 is a new electrical standard which is very similar to TIA/EIA-232-F, but supports higher data rates (512 kbps). It is an electrical only standard, which is intended to be referenced by complete standards, such as TIA/EIA-723. TIA/EIA-694 specifies an unbalanced, unidirectional, point-to-point interface. This standard supports inter-operability with TIA/EIA-232-F devices. *Figure 6* illustrates a typical application, and *Table 4* lists the major electrical requirements.

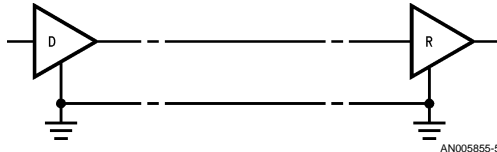

FIGURE 6. Typical TIA/EIA-694 Application

Key Features of the standard are:

- Unbalanced Driver and Receiver
- Point-to-Point
- Inter-Operability with TIA/EIA-232-F Devices
- 512 kbps Maximum Data Rate

TABLE 4. TIA/EIA-694 Major Electrical Specifications

Parameter	Limit & Units
Driver Open Circuit Output Voltage	$\leq 5.5V $
Driver Loaded Output Voltage (3 k Ω)	$\geq 3.0V $
Driver Short Circuit Current	$\leq 100 \text{ mA} $
Driver Transition Time	Controlled
Receiver Input Resistance	$\geq 3 \text{ k}\Omega$
Maximum Receiver Input Voltage	$\pm 12V$
Receiver Thresholds	$\pm 2V$

TIA/EIA BALANCED (DIFFERENTIAL) STANDARDS

TIA/EIA-422-B

TIA/EIA-422-B is an electrical standard, specifying a balanced driver and balanced receivers. The receivers' requirements are identical to the receivers' requirements specified in TIA/EIA-423-B. This standard specifies a unidirectional, single driver, multiple receivers, terminated, balanced interface. *Figure 7* illustrates a point-to-point typical application with termination located at the receiver input (end of cable). *Figure 8* illustrates a fully loaded TIA/EIA-422-B interface. Again termination is located at the end of the cable, also stub length should be minimized to limit reflections. *Table 5* lists the major electrical requirements of the TIA/EIA-422-B Standard.

Key Features of the standard are:

- Balanced Interface
- Multi-Drop (Multiple Receiver Operation)
- 10 Mbps Maximum Data Rate (@ 40 feet)
- 4000 Foot Maximum Cable Length (@ 100 kbps)

TABLE 5. TIA/EIA-422-B Major Electrical Specifications

Parameter	Limit & Units
Driver Open Circuit Voltage	$\leq 10V $
Driver Loaded Output Voltage	$\geq 2.0V $
Balance of Loaded Output Voltage	$\leq 400 \text{ mV}$
Driver Output Offset Voltage	$\leq 3.0V$
Balance of Offset Voltage	$\leq 400 \text{ mV}$
Driver Short Circuit Current	$\leq 150 \text{ mA} $
Driver Leakage Current	$\leq 100 \mu\text{A} $
Driver Output Impedance	$\leq 100\Omega$
Receiver Input Resistance	$\geq 4 \text{ k}\Omega$
Receiver Thresholds	$\pm 200 \text{ mV}$
Receiver Internal Bias	$\leq 3.0V$
Maximum Receiver Input Current	3.25 mA
Receiver Common Mode Range	$\pm 7V (\pm 10V)$
Receiver Operating Differential Range	$\pm 200 \text{ mV}$ to $\pm 6V$
Maximum Differential Input Voltage	$\pm 12V$

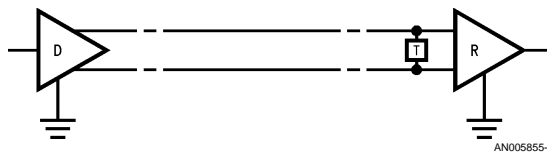
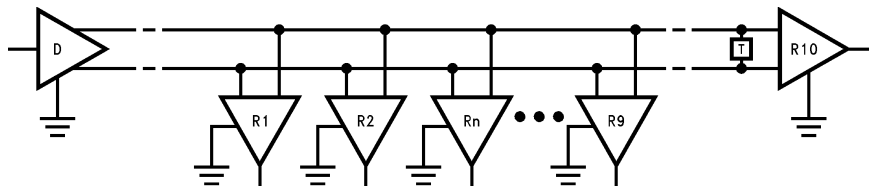

FIGURE 7. Typical TIA/EIA-422-B Point-to-Point Application



AN005855-7

FIGURE 8. Typical TIA/EIA-422-B Multidrop Application

TIA/EIA-485-A

TIA/EIA-485-A is an electrical standard, specifying balanced drivers and receivers. It provides all the advantages of TIA/EIA-422-B along with supporting multiple driver operation. TIA/EIA-485-A is the only TIA/EIA standard that allows for multiple driver operation at this time. This fact allows for multipoint (party line) configurations. The standard specifies a bi-directional (half duplex), multipoint interface. Figure 9 illustrates a typical multipoint application, and Table 6 lists the major electrical requirements. For additional applications information, refer to the TIA System Bulletin (TSB89).

Key Features are:

- Balanced Interface
- Multipoint Operation
- Operation From a Single +5V Supply
- -7V to +12V Bus Common Mode Range
- Up to 32 Transceiver Loads (Unit Loads)
- 10 Mbps Maximum Data Rate (@ 40 feet)
- 4000 Foot Maximum Cable Length (@ 100 kbps)

TABLE 6. TIA/EIA-485-A Major Electrical Specifications

Parameter	Limit & Units
Driver Open Circuit Voltage	$\leq 6.0V $
Driver Loaded Output Voltage	$\geq 1.5V $
Balance of Driver Loaded Output Voltage	$\leq 200 mV $
Maximum Driver Offset Voltage	3.0V
Balance of Driver Offset Voltage	$\leq 200 mV $
Driver Transition Time	$\leq 30\% T_{ui}$
Driver Short Circuit Current (-7V to +12V)	$\leq 250 mA $
Receiver Thresholds	$\pm 200 mV$
Maximum Bus Input Current +12V/-7V	$\leq 1.0 mA \leq 0.8 mA$
Max. Unit Loads	32

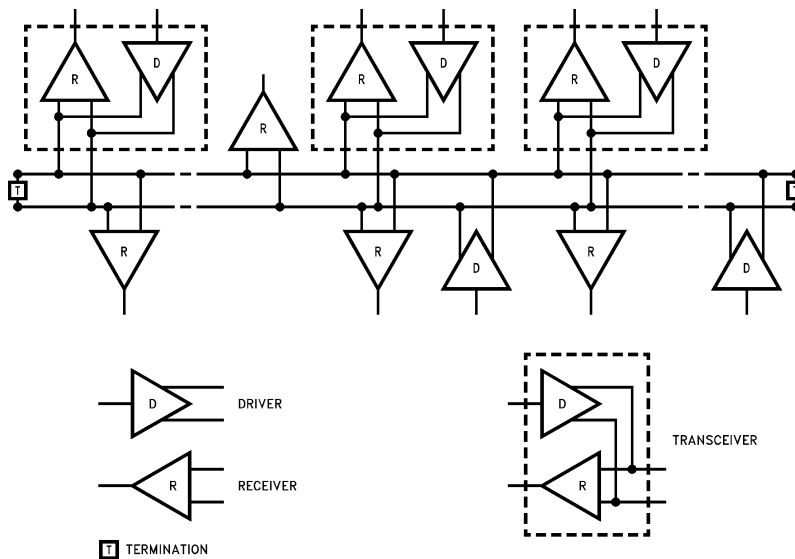

AN005855-8

FIGURE 9. Typical TIA/EIA-485-A Application

TIA/EIA BALANCED (DIFFERENTIAL) STANDARDS

TIA/EIA-612

TIA/EIA-612 is an electrical standard, specifying a balanced driver and balanced receiver. This standard specifies data rates up to 52 Mbps using ECL technology. This standard specifies a unidirectional, point-to-point interface. *Figure 10* illustrates a typical application with termination located at the receiver input (end of cable). *Table 7* lists the major electrical requirements of the TIA/EIA-612 Standard. This Standard is referenced by TIA/EIA-613, and together implement a HSSI (High Speed Serial Interface).

TABLE 7. TIA/EIA-612 Major Electrical Specifications

Parameter	Limit and Units
Driver Open Circuit Voltage	$\leq 1.5V $
Driver Loaded Output Voltage	$\geq 590\text{ mV} $
Balance of Loaded Output Voltage	$\leq 100\text{ mV} $
Driver Output Offset Voltage	$\leq 0V$ and $\geq -1.6V$
Balance of Offset Voltage	$\leq 100\text{ mV} $
Driver Short Circuit Current	$\leq 50\text{ mA}$
Receiver Thresholds	$\pm 150\text{ mV}$
Receiver Input Range	$-0.5V$ to $-2.0V$
Receiver Input Current	$\leq 350\text{ }\mu\text{A}$
Maximum Differential Input Voltage	$\leq 1.5V$

TIA/EIA-644 (LVDS)

TIA/EIA-644 is an electrical standard, specifying a balanced driver and a balanced receiver(s). This standard specifies data rates up to 655 Mbps (application / device dependent, higher is possible) using LVDS (Low Voltage Differential Signaling) technology. This standard specifies a unidirectional, point-to-point interface. Multiple receivers are supported under certain application limitations. *Figure 10* illustrates the typical point-to-point application with termination (required) located at the receiver input (end of cable). *Table 8* list the major electrical requirements of the TIA/EIA-644 Standard. This Standard is intended to be referenced by other standards which specify the complete interface.

TABLE 8. TIA/EIA-644 LVDS Major Electrical Specifications

Parameter	Limit and Units
Driver Output Voltage	$247\text{ mV} \leq V_{diff} \leq 454\text{ mV}$
Driver Offset Voltage	$1.125V \leq V_{OS} \leq 1.375$
Driver Short Circuit Current	$\leq 24\text{ mA}$
Receiver Thresholds	$\pm 100\text{ mV}$
Receiver Input Range	$0V$ to $+2.4V$
Receiver Differential Input Range	100 mV to 600 mV
Receiver Input Current	$\pm 20\text{ }\mu\text{A}$

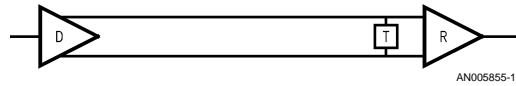

FIGURE 10. Typical TIA/EIA-612 and TIA/EIA-644 Point-to-Point Application

OTHER TIA/EIA STANDARDS

TIA/EIA-232-F

TIA/EIA-232-F is a standard specifying a DTE/DCE serial interface. It is a complete standard specifying the function of the lines (Data, Timing, & Control) and a 25 position connector. The standard supports data rates up to 20 kbps. Two connector options are provided; a common 25 position D connector, and a smaller 26 position connector.

EIA-334-A

EIA-334-A defines signal quality terms for synchronous serial DTE/DCE interfaces. This standard is referenced by the complete synchronous standards.

EIA-363

EIA-363 defines signal quality terms for non-synchronous serial DTE/DCE interfaces. This standard is referenced by the complete non-synchronous standards.

EIA-404-A

EIA-404-A defines signal quality for start-stop non-synchronous DTE/DCE interfaces.

EIA-449

EIA-449 was a standard specifying a general purpose DTE/DCE serial interface. It was a complete standard specifying the function of the lines (Data, Timing, & Control) and a 37 position connector. This standard referenced 422 and 423 standards for line driver and receiver requirements and characteristics. The standard supports data rates up to 2 Mbps. The size of the specified connector has prevented wide spread acceptance of this standard. New designs are utilizing TIA/EIA-530-A instead of EIA-449 (RS-449).

TIA/EIA-530-A

TIA/EIA-530-A is a complete standard specifying a high speed DTE/DCE serial interface. It is a complete standard specifying the function of the lines (Data, Timing, & Control) and a 25 position connector. This standard references TIA/EIA-422-B and TIA/EIA-423-B standards for line driver and receiver requirements and characteristics. The standard supports data rates up to 2.1 Mbps. Two connector options are provided; a common 25 position D connector, and a smaller 26 position connector.

Note: Connector pinout differences exists between EIA-530 and TIA/EIA-530-A.

TIA/EIA-561

TIA/EIA-561 is a complete standard specifying a non-synchronous DTE/DCE serial interface. It is a complete standard specifying the function of the lines (Data, Timing & Control) and a small 8 position connector (MJ8). This standard references TIA/EIA-562 standard for line driver and receiver requirements and characteristics. The standard supports data rates up to 38.4 kbps.

TIA/EIA-574

TIA/EIA-574 is a complete standard specifying a non-synchronous DTE/DCE serial interface. It is a complete standard specifying the function of the lines (Data, Timing, & Control) and a 9 position connector. This standard references TIA/EIA-562 standard for line driver and receiver requirements and characteristics. The standard supports data rates up to 38.4 kbps.

TIA/EIA-613

TIA/EIA-613 is a complete standard specifying a general purpose DTE/DCE interface for data rates up to 52 Mbps. This standard specifies functional and connector specifications and references TIA/EIA-612 for electrical characteristics. Together TIA/EIA-612 and TIA/EIA-613 implement a HSSI interface.

TIA/EIA-687

TIA/EIA-687 is a medium speed standard specifying a DTE/DCE serial interface. It is a complete standard specifying the function of the lines (Data, Timing, & Control) and a 25 or 26 position connector. This standard references TIA/EIA-423-B standard for line driver and receiver requirements and characteristics.

TIA/EIA-688

TIA/EIA-688 is a standard specifying a DTE/DCE serial interface for Digital Cellular Equipment. It is a complete standard specifying the function of the lines (Data, Timing, & Control) and a 12 position (plus coax) connector. This standard references TIA/EIA-694 standard for line driver and receiver requirements and characteristics. The standard supports data rates up to 512 kbps.

TIA/EIA-723

TIA/EIA-723 is a complete standard specifying a high speed DTE/DCE serial interface. It is a complete standard specifying the function of the lines (Data, Timing, & Control) and a 25 or 26 position connector. This standard references TIA/EIA-694 standard for line driver and receiver requirements and characteristics. The standard supports data rates up to 512 kbps.

CCITT Recommendations / ITU-T Recommendations

CCITT (International Telegraph and Telephone Consultative Committee) creates and maintains standards which are intended to help standardize international telecommunication services. These standards are recommended technical practices and approaches, however, in some countries they can be considered mandatory. CCITT reviews its standards on a 4 year cycle. Many of the Interface standards are located in volume eight of the CCITT "V" series. This volume is titled "Data Communication over the Telephone Network". Some of the Interface standards are also covered in the "X" series. The CCITT prefix has been replaced by ITU for International Telecommunications Union and the term CCITT will eventually be phased out. A cross reference is provided in *Table 9*.

TABLE 9. V and X Series Cross Reference

V Series	X Series
V.10	X.26
V.11	X.27

Recommendation V.10

Recommendation V.10 defines the electrical characteristics for an unbalanced interface. This recommendation specifies an unbalanced driver and a balanced receiver. With the exception of generator (driver) open circuit output voltage specification, V.10 generator (driver) requirements are very similar to the TIA/EIA-423-B standard. In V.10 the driver is loaded with a 3.9 k Ω resistor to ground, while in the TIA/EIA-423-B standard the driver is unloaded. The V.10 re-

ceiver is specified with ± 300 mV thresholds, while the TIA/EIA-423-B receiver supports a tighter specification of ± 200 mV. Other smaller differences also exist. Therefore, for exact conditions and requirements consult the respective standards.

Recommendation V.11

Recommendation V.11 defines the electrical characteristics for a balanced interface. V.11 specifies a balanced driver and balanced receivers. With the exception of generator (driver) open circuit output voltage specification, V.11 generator (driver) requirements very similar to the TIA/EIA-422-B standard. V.11 requires a $3.9\text{ k}\Omega$ differential load for the driver's open circuit output, while TIA/EIA-422-B test conditions require no load (open circuit). The Receiver specifications are also very similar, with the exception of the input threshold specification. Recommendation V.11 requires thresholds of ± 300 mV while TIA/EIA-422-B requires a tighter specification of ± 200 mV. Other smaller differences also exist. Therefore, for exact conditions and requirements consult the respective standards.

Recommendation V.24

Recommendation V.24 defines the function of interchange circuits for DTE/DCE interfaces. Circuit class (Data, Timing, or Control), direction, and definition are all defined in this recommendation. V.24 is intended to be referenced by other recommendations.

Recommendation V.28

Recommendation V.28 defines the electrical characteristics for an unbalanced interface. This standard specifies driver output and receiver input characteristics. The standard is very similar to the Electrical section (2) of the TIA/EIA-232-F standard. The one notable exception in the generator (driver) requirements is the slew rate specification. The TIA/EIA-232-F lower limit for slew rate is $3\text{ V}/\mu\text{s}$ (@20 kbps), (measured between the +3V and -3V level), while in V.28 the lower limit is $4\text{ V}/\mu\text{s}$ (@20 kbps). Both standards specify the same upper limit of $30\text{ V}/\mu\text{s}$ under light loading conditions. TIA/EIA-232-F defines the complete interface, while V.28 only defines the electrical section of TIA/EIA-232-F. The complete interface standard is covered by CCITT Recommendations V.28 (electrical), V.24 (functional), and ISO 2110 & 4902 (mechanical). For complete specifications refer to CCITT Recommendation V.28.

Recommendation V.35

Recommendation V.35 is actually a modem standard that also defines a balanced interface. While many applications operate at data rates substantially higher than 48 kbps (typi-

cally > 1 Mbps), the interface is only defined to operate up to 48 kbps. For low speed control lines the standard recommends the use of V.28 generators (drivers) and receivers. For use on high speed data and timing lines the standard recommends the use of unique V.35 balanced generators (drivers). The drivers feature a small swing of $\pm 0.55\text{V}$ across a termination load of 100Ω . The generator is also specified to have polar swings around ground, yielding a 0V offset voltage. Most implementations use differential current mode drivers with external resistors to implement V.35 balanced generators. V.35 has been rescinded, and V.10 and V.11 generators are recommended as replacements.

US MILITARY STANDARDS

MIL STD 188C (Low Level)

Military Standard 188C (MIL-STD-188C) is similar to TIA/EIA-232-F in the fact that it specifies an unbalanced point-to-point interface. However, the driver's requirements are slightly different. The driver is still required to develop a $| 5\text{V} |$ level. The maximum driver output level is specified at $| 7\text{V} |$, and the match between V_{OL} and V_{OH} levels must be within 10% of each other. The driver's slew rate is specified to be between 5% and 15% of the applicable modulation rate. Most drivers require an external capacitor to control the slew rate. Figure 11 illustrates a typical application, and Table 10 lists the major electrical specification of MIL-STD-188C.

TABLE 10. MIL-STD-188C Major Electrical Specifications

Parameter	Limit & Units
Unloaded Driver Output Level	$\pm 5\text{V}$ Min., $\pm 7\text{V}$ Max.
Driver Output Resistance (Power ON) ($I_O \leq 10\text{ mA}$)	100Ω Max.
Driver Output Short Circuit Current	$\pm 100\text{ mA}$
Driver Output Slew Rate	5% to 15% of Modulation Rate
Receiver Input Resistance	$\geq 6\text{ k}\Omega$
Receiver Input Thresholds	$\pm 100\ \mu\text{A}$

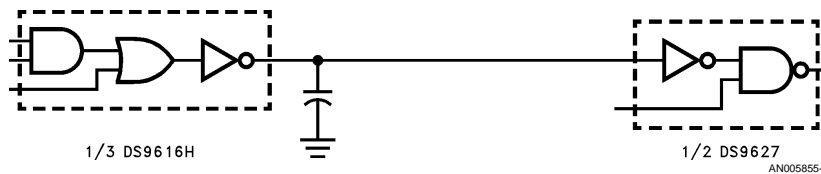

FIGURE 11. Typical MIL-STD-188C Application

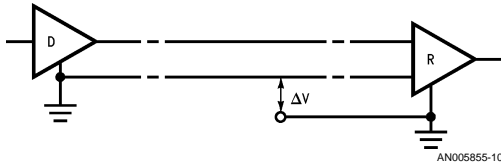

FIGURE 12. MIL STD 188-114A Unbalanced Typical Application

MIL STD 188-114A

Military Standard 188-114 specifies four different interfaces; three balanced and one unbalanced. The balanced interfaces are divided into three types, two of which are voltage mode, and one of which is current mode. See Figure 12, Figure 13 and Figure 14. Voltage mode, type 1, defines an interface for data rates up to 100 kbps. An additional requirement of type 1 is a polar (around ground) output swing. This provides a zero offset output voltage. Voltage mode, type 2, drivers operate up to 10 Mbps and require the same parameters as TIA/EIA-422-B drivers. Additionally, type 2, drivers can have an output offset up to 3V. Current mode, type 3, drivers operate beyond 10 Mbps. The receiver specified for type 1 & 2 balanced, and unbalanced drivers are identical to the receivers specified in TIA/EIA-422-B and TIA/EIA-423-B standards.

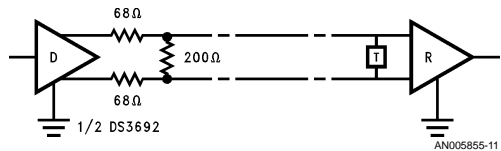

FIGURE 13. MIL STD 188-114A Balanced, Type 1 Typical Application

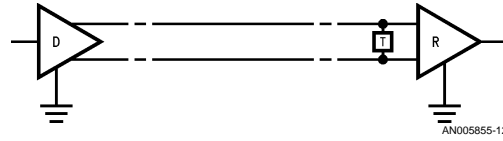

FIGURE 14. MIL STD 188-114A Balanced, Type 2 Typical Application

MIL STD 1397

Military Standard 1397 specifies two interfaces. These are termed "slow" and "fast". The slow interface operates up to 42 kbps, while the fast interface is defined to operate up to 250 kbps. Comparators and/or discretes components are used to implement drivers and receivers.

FEDERAL TELECOMMUNICATIONS STANDARDS

Federal Standards are from the Federal Telecommunications Standards Committee, which is an advisory committee that adopts TIA/EIA interface standards.

FED STD 1020A

The FEDSTD 1020A is identical to TIA/EIA-423-B. It is intended for United States, non-military government use.

FED STD 1030A

The FEDSTD 1030A is identical to TIA/EIA-422-B. It is intended for United States, non-military government use.

OTHER STANDARDS

IEEE488

The IEEE (Institute of Electrical and Electronics Engineers) also has a standard developing arm. Generally the IEEE standards deal with complete Bus specifications. IEEE488 is a complete Bus standard covering the electrical, mechanical, and functional specification of a parallel instrumentation bus. The bus is commonly used for communication of lab test equipment and machinery control. The standard allows for 15 devices to be connected together, over cable lengths up to 60 feet. The standard defines 16 lines composed of 3 control, 5 management, and 8 data lines. The major electrical specifications are summarized in Table 11.

TABLE 11. Major IEEE488 Electrical Requirements

Symbol	Parameter	Conditions	Min	Max	Units
V_{OH}	Driver Output Voltage	$I_{OH} = -5.2 \text{ mA}$	2.4		V
V_{OL}	Driver Output Voltage	$I_{OL} = 48 \text{ mA}$		0.4	V
I_{OZ}	Driver Output Leakage Current	$V_O = 2.4V$		± 40	μA
I_{OH}	Driver Output Current Open Collector	$V_O = 5.25V$		250	μA
V_{IH}	Receiver Input Voltage		2.0		V
V_{IL}	Receiver Input Voltage			0.8	V
I_{IH}	Receiver Input Current	$V_{IN} = 2.4V$		40	μA
I_{IL}	Receiver Input Current	$V_{IN} = 0.4V$		-1.6	mA
I_{CL}	Receiver Clamp Current	$V_{IN} = -1.5V$		12	mA
RL_1	Termination Resistor	$V_{CC} = 5V \pm 5\%$	2850	3150	Ω
RL_2	Termination Resistor	$V = GND$	5890	6510	Ω

GA-22-6974-0

IBM specification GA-22-6974-0 specifies the electrical characteristics, format of information, and the control scheme of an unbalanced interface. This interface is mainly used on 360/370 equipment and allows up to 10 I/O ports. This unbalanced interface employs 95Ω terminated coax cable. Drivers normally feature open-emitter designs, and

short-circuit limiting. Receivers normally feature hysteresis to prevent output oscillations for slow rising inputs in noisy environments. Care should be taken to limit cable lengths such that noise is limited to less than 400 mV. Figure 15 illustrates a typical application, and Table 12 lists the major electrical requirements.

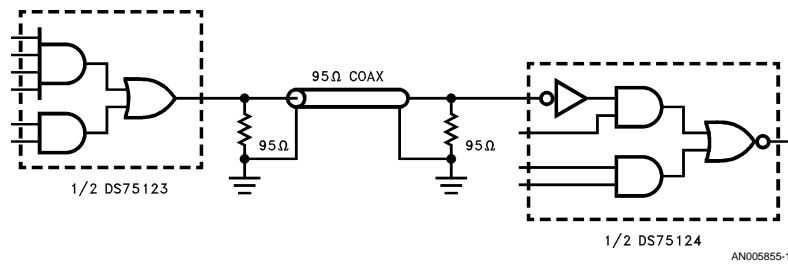

FIGURE 15. GA-22-6974-0 Typical Application

TABLE 12. Major Electrical Requirements of GA-22-6974-0

Symbol	Parameter	Conditions	Min	Max	Units
V_{OH}	Driver Output Voltage	$I_{OH} = 123 \text{ mA}$		7	V
V_{OH}		$I_{OH} = 30 \mu\text{A}$		5.85	V
V_{OH}		$I_{OH} = 59.3 \text{ mA}$	3.11		V
V_{OL}		$I_{OL} = -240 \mu\text{A}$		0.15	V
V_{IH}	Receiver Input Threshold			1.7	V
V_{IL}			0.7		V
I_{IH}	Receiver Input Current	$V_{IN} = 3.11\text{V}$		-0.42	mA
I_{IL}		$V_{IN} = 0.15\text{V}$	0.24		mA
V_{IN}	Receiver Input Voltage Range		-0.15	7	V
V_{IN}			-0.15	6	V
R_{IN}	Receiver Input Impedance	$0.15\text{V} \leq V_{IN} \leq 3.9\text{V}$	7.4		kΩ
I_{IN}	Receiver Input Current	$V_{IN} = 0.15\text{V}$		240	μA
Z_O	Cable Impedance		83	101	Ω
R_O	Cable Termination	$PD \leq 390 \text{ mW}$	90	100	Ω
	Noise (Signal and Ground)			400	mV

CONCLUSION

This application note provides a brief overview of various interface standards from several standardization organizations. It is only intended to point out the major requirements of each standard and to illustrate a typical application. When selecting or designing a standardized interface it is highly recommended to carefully review the complete standard.

Standards can be ordered from the respective organizations or from:

Global Engineering Documents
 15 Inverness Way East
 Englewood, CO 80112-5704 USA
 USA and Canada 1-800-854-7179
 International 303-397-7956
<http://global.ihs.com/>



LIFE SUPPORT POLICY

NATIONAL'S PRODUCTS ARE NOT AUTHORIZED FOR USE AS CRITICAL COMPONENTS IN LIFE SUPPORT DEVICES OR SYSTEMS WITHOUT THE EXPRESS WRITTEN APPROVAL OF THE PRESIDENT OF NATIONAL SEMICONDUCTOR CORPORATION. As used herein:

1. Life support devices or systems are devices or systems which, (a) are intended for surgical implant into the body, or (b) support or sustain life, and whose failure to perform when properly used in accordance with instructions for use provided in the labeling, can be reasonably expected to result in a significant injury to the user.
2. A critical component in any component of a life support device or system whose failure to perform can be reasonably expected to cause the failure of the life support device or system, or to affect its safety or effectiveness.

 <p>National Semiconductor Corporation Americas Tel: 1-800-272-9959 Fax: 1-800-737-7018 Email: support@nsc.com</p>	<p>National Semiconductor Europe Fax: +49 (0) 1 80-530 85 86 Email: europe.support@nsc.com Deutsch Tel: +49 (0) 1 80-530 85 85 English Tel: +49 (0) 1 80-532 78 32 Français Tel: +49 (0) 1 80-532 93 58 Italiano Tel: +49 (0) 1 80-534 16 80</p>	<p>National Semiconductor Asia Pacific Customer Response Group Tel: 65-2544466 Fax: 65-2504466 Email: sea.support@nsc.com</p>	<p>National Semiconductor Japan Ltd. Tel: 81-3-5620-6175 Fax: 81-3-5620-6179</p>
--	---	--	---

www.national.com

National does not assume any responsibility for use of any circuitry described, no circuit patent licenses are implied and National reserves the right at any time without notice to change said circuitry and specifications.